

SMT405-S1

High Performance TOP LED

<Specifications>

1. Product Name: TOP LED
2. Type Number: SMT405-S1
3. Chip:
 - Chip Material: InGaN
 - Peak Wavelength: 405nm
4. Package
 - Lead Frame Die: Silver Plated
 - Package Resin: PA6T Resin
 - Lens: Silicone Resin

Outer Dimension (Unit:mm)

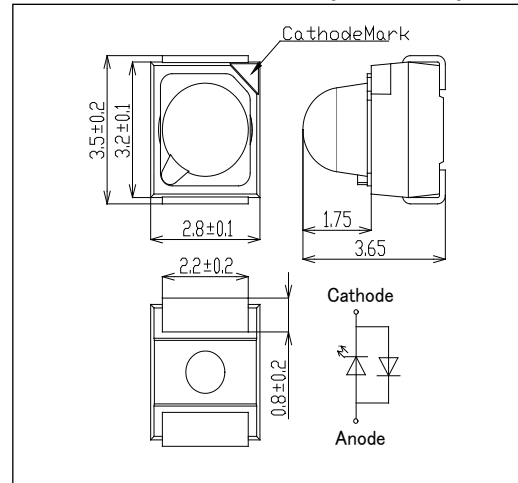

Absolute Maximum Ratings[Ta=25°C]			
Item	Symbol	Value	Unit
Power Dissipation	PD	200	mW
Forward Current	IF	50	mA
Pulse Forward Current*	IFP	100	mA
Reverse Voltage	VR	Not designed for reverse operation	V
Thermal Resistance	Rthja	80	K/W
Junction Temperature	Tj	120	°C
Operating Temperature	TOPR	-40 ~ +100	°C
Storage Temperature	TSTG	-40 ~ +100	°C
Soldering Temperature**	TSOL	250	°C

* Duty=1% and Pulse Width=10us.

** Soldering condition must be completed within 3 second at 250 °C.

Electro-Optical Characteristics [Ta=25°C]						
Item	Symbol	Condition	Minimum	Typical	Maximum	Unit
Forward Voltage	VF	IF=20mA		3.1	4.0	V
	VFP	IFP=100mA		4.0		
Total Radiated Power*	PO	IF=20mA		26		mW
		IFP=100mA		110		
Radiant Intensity**	IE	IF=20mA		17		mW/sr
		IFP=100mA		75		
Luminous Flux	ΦV	IF=20mA		90		mlm
Peak Wavelength	λP	IF=20mA	395	405	415	nm
Half Width	Δλ	IF=20mA		15		nm
Viewing half Angle	θ1/2	IF=20mA		±6		deg
Rise Time	tr	IF=20mA		35		ns
Fall Time	tf	IF=20mA		45		ns

* Measured by S3584-08

** Measured by CIE127-2007 Condition B



Forward Current - Forward Voltage

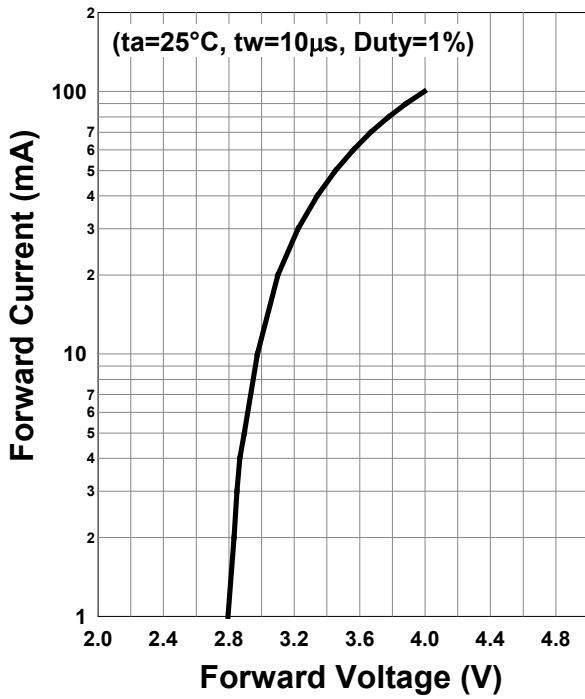

Relative Radiant Intensity - Forward Current

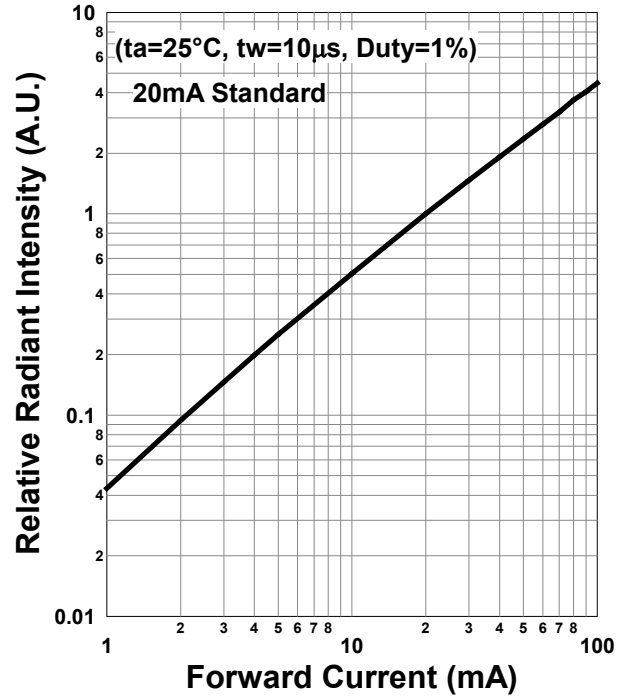

Forward Current - Pulse Duration

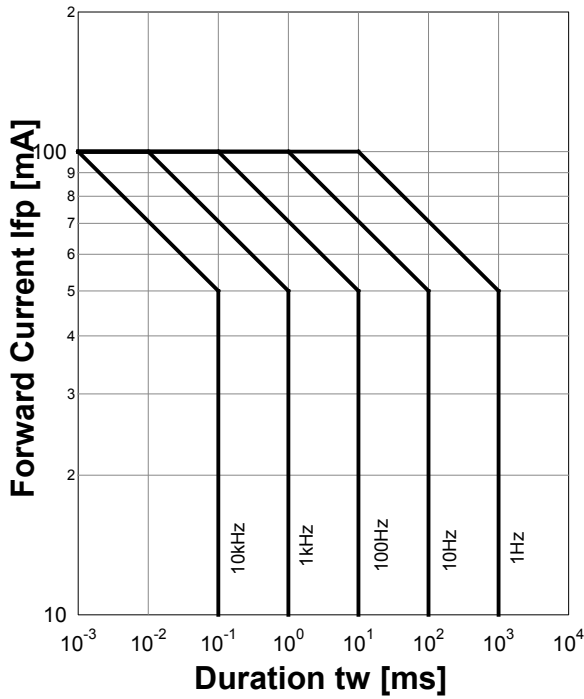

Allowable Forward Current - Ambient Temperature

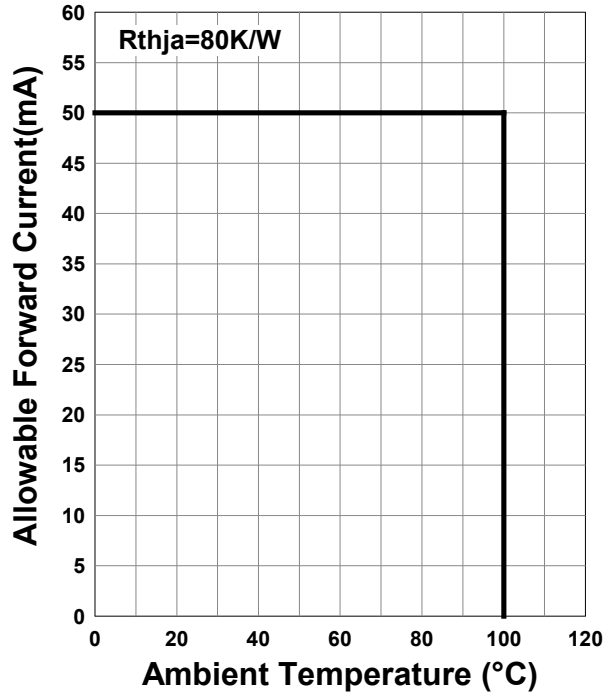

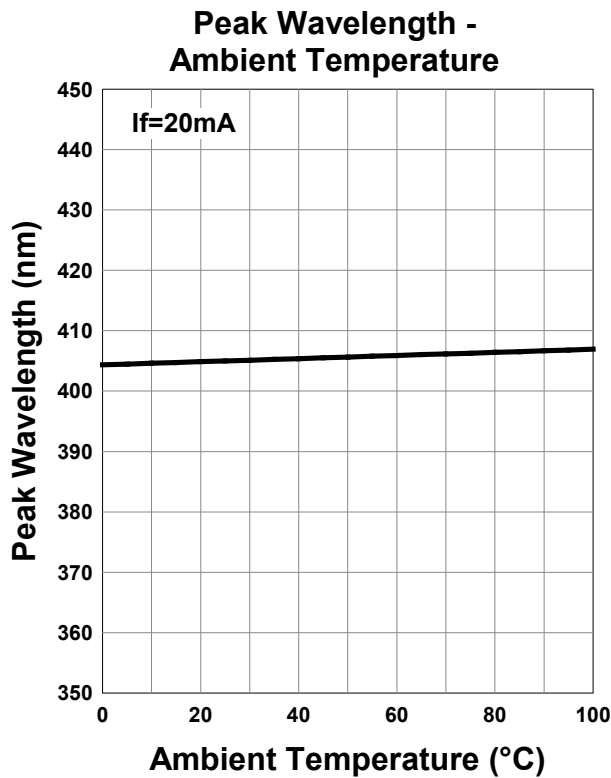
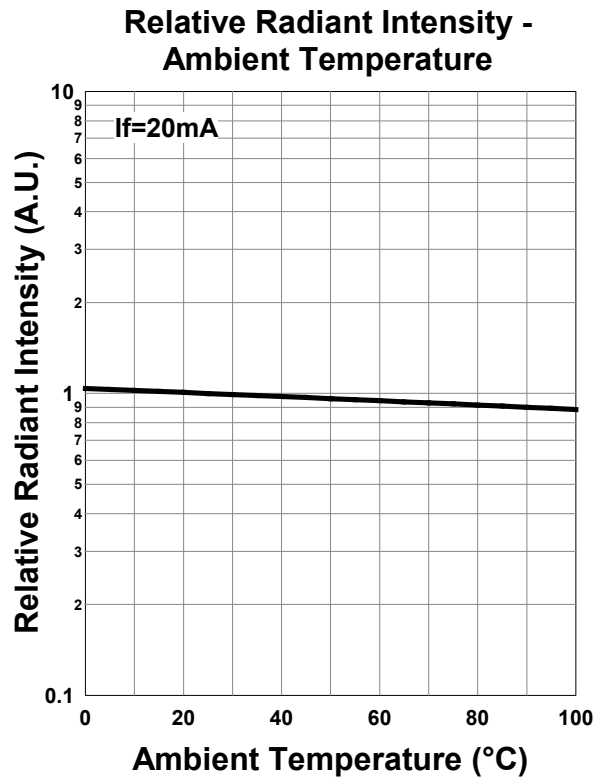
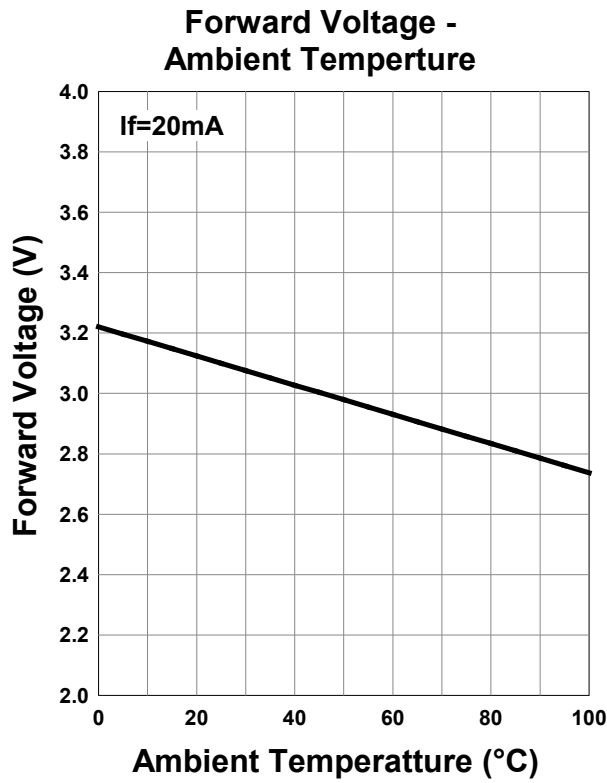

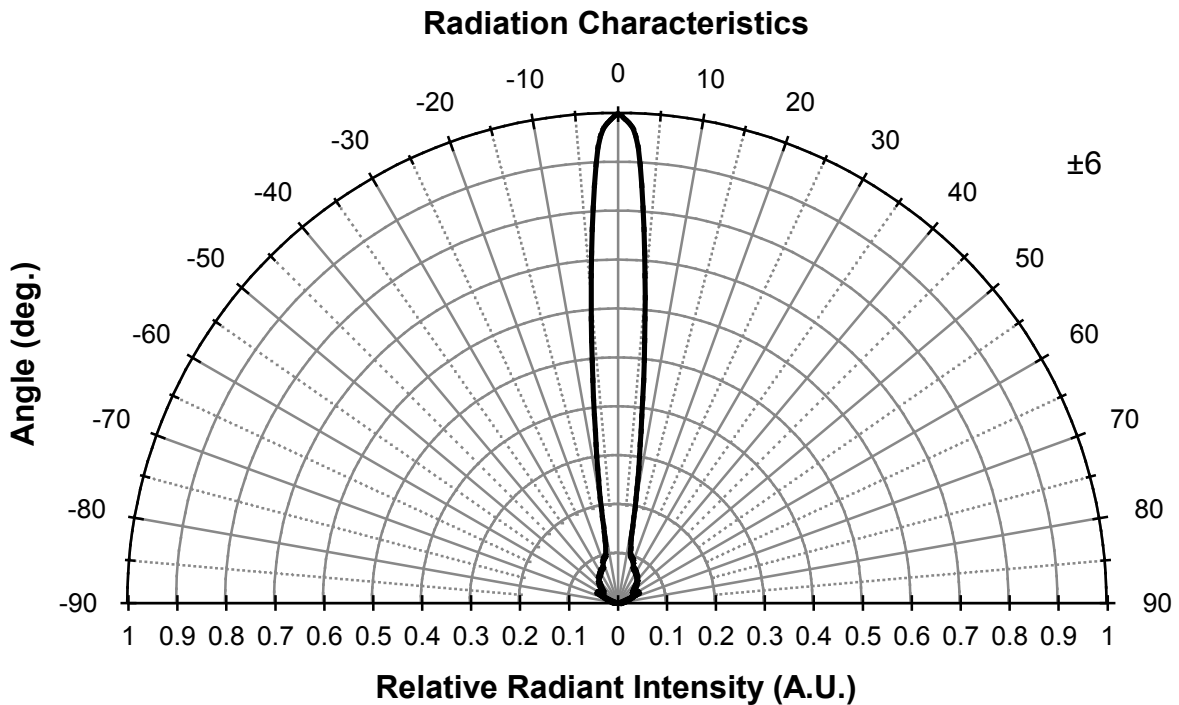
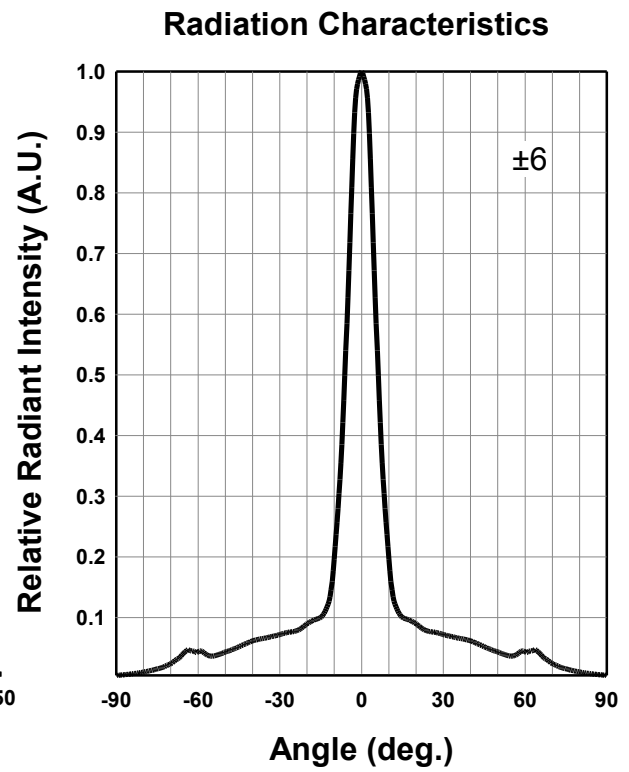
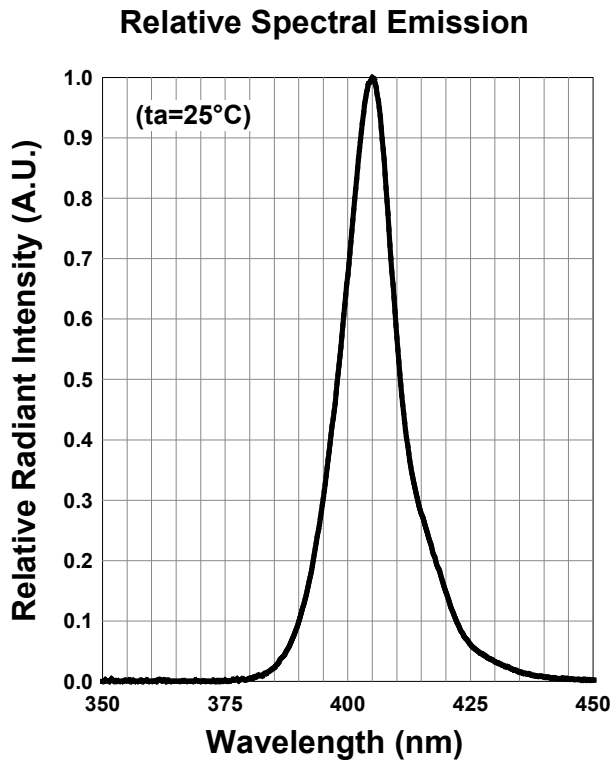

◆SMD Application

◆Recomended Lnd Layout (Unit : mm)

IR-Reflow Soldering Profile for lead free soldering

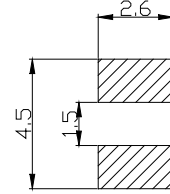
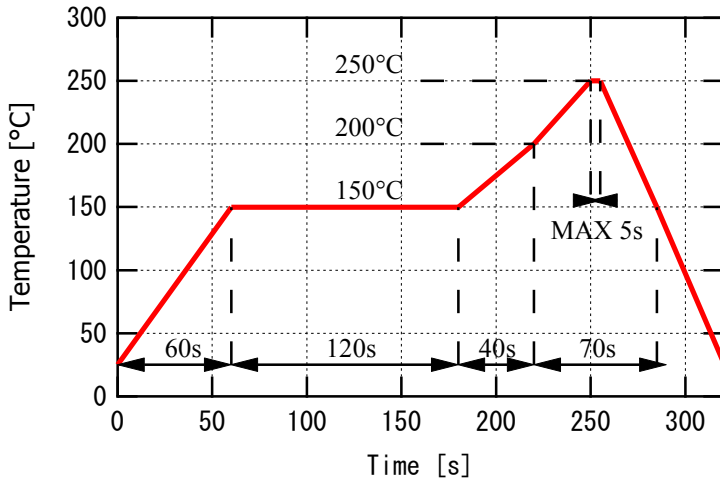

◆SMD Packing

Tape and Reel Dimensions (Unit: mm)

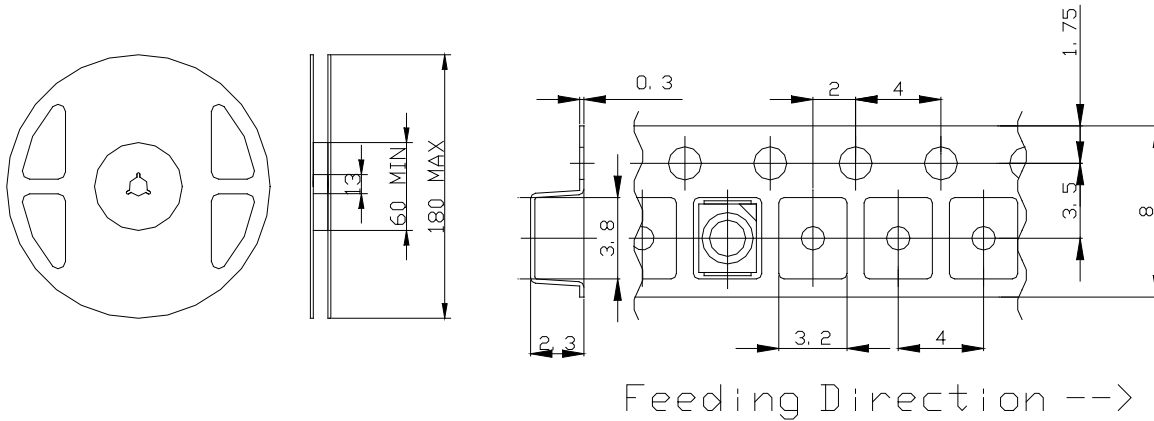

◆Wrapping

Moisture barrier bag aluminum laminated film with a desiccant to keep out the moisture absorption during the transportation and storage.

Disclaimer

Product specifications and data shown in this product catalog are subject to change without notice for the purposes of improving product performance, reliability, design, or otherwise.

Product data and parameters in this catalog are typical values based on reasonably up-to-date measurements. Product data and parameters may vary by user application and over time.

Products shown in this catalog are intended to be used for general electronic equipment. Products are not guaranteed for applications where product malfunction or failure may cause personal injury or death, including but not limited to life-supporting / saving devices, medical devices, safety devices, airplanes, aerospace equipment, automobiles, traffic control systems, and nuclear reactor control systems.

2014.06