

SMBB740D-1100-05

High Power Top LED

SMBB740D-1100-05 is an AlGaAs LED mounted on copper heat sink with a 5*5 mm package

These devices are available to be operated and 500mW/sr at IFP=2A.

Specifications

- 1) Product Name High Power Top LED
- 2) Type No. SMBB740D-1100-05
- 3) Chip
- (1) Chip Material AlGaAs
- (2) Chip Dimension 1000um*1000um
- (3) Chip Number 1pce
- (4) Peak Wavelength 740nm typ.
- 4) Package
- (1) Lead Frame Die Silver Plated on Copper
- (2) Package Resin PA9T Resin
- (3) Lens Silicone Resin

Outer dimension (Unit: mm)

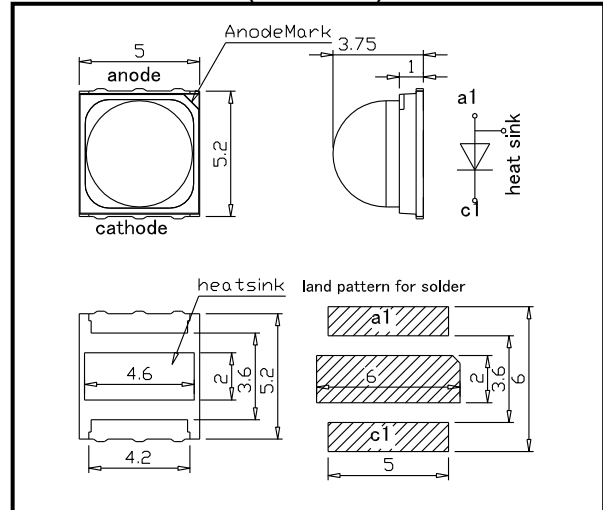

Absolute Maximum Ratings [Ta=25°C]

Item	Symbol	Maximum Rated Value	Unit
Power Dissipation	PD	2000	mW
Forward Current	IF	800	mA
Pulse Forward Current	IFP	2000	mA
Reverse Voltage	VR	5	V
Thermal Resistance	Rthja	10	K/W
Junction Temperature	Tj	120	°C
Operating Temperature	TOPR	-40 ~ +100	°C
Storage Temperature	TSTG	-40 ~ +100	°C
Soldering Temperature	TSOL	250	°C

‡Pulse Forward Current condition: Duty=1% and Pulse Width=10us.

‡Soldering condition: Soldering condition must be completed within 5 seconds at 250°C

Electro-Optical Characteristics [Ta=25°C typ.]

Item	Symbol	Condition	Minimum	Typical	Maximum	Unit
Forward Voltage	VF	IF=600mA		2.0	2.4	V
	VFP	IFP=2A		2.7		
Radiated Power	Po	IF=600mA		290		mW
		IFP=2A		960		
Radiant Intensity	IE	IF=600mA		150		mW/sr
		IFP=2A		500		
Peak Wavelength	λP	IF =600mA	730	740	750	nm
Half Width	Δλ	IF =600mA		27		nm
Viewing Half Angle	θ1/2	IF =100mA		±45		deg.
Rise Time	tr	IF =600mA		90		ns
Fall Time	tf	IF =600mA		90		ns

‡Radiated Power is measured by S3584-08.

‡Radiant Intensity is measured by CIE127-2007 Condition B.

Forward Current - Forward Voltage

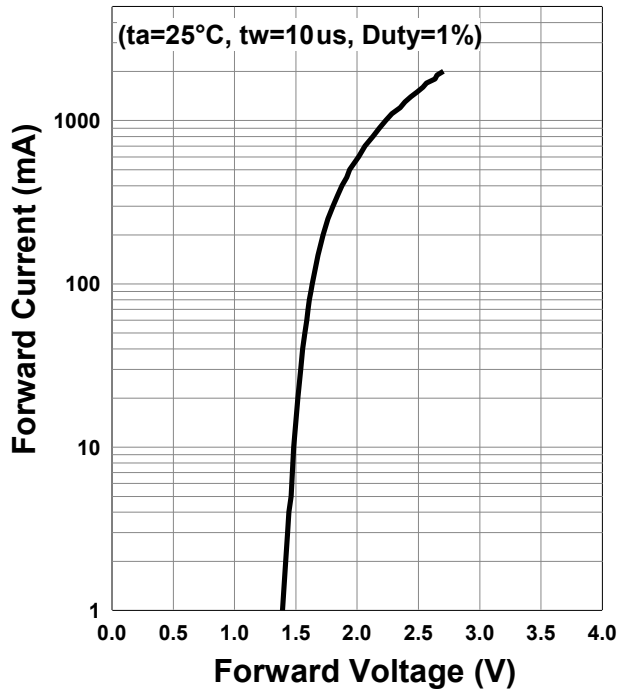

Relative Radiant Intensity - Forward Current

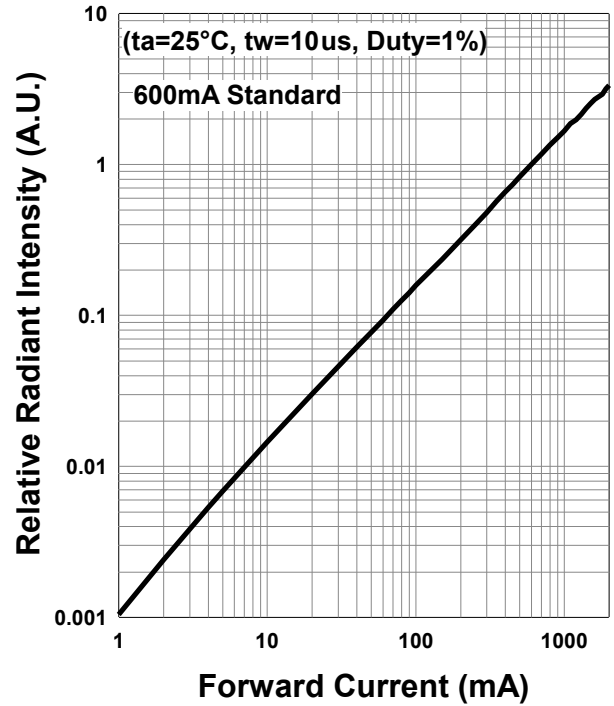

Forward Current - Pulse Duration

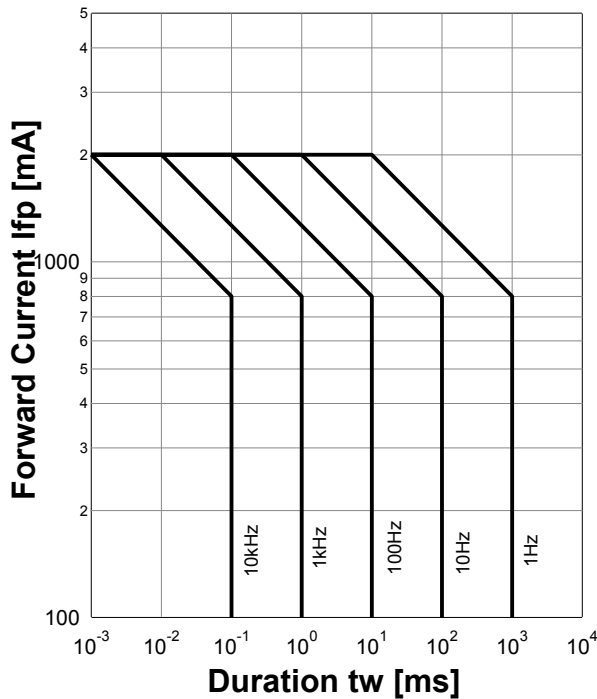

Allowable Forward Current - Ambient Temperature

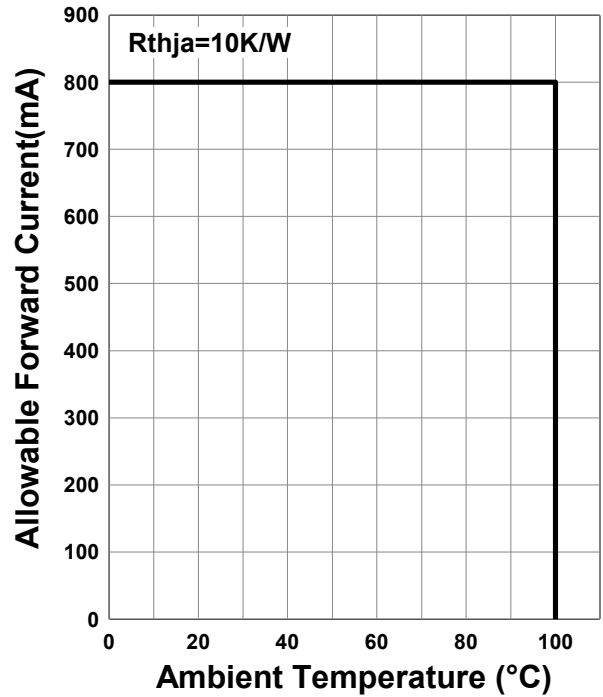

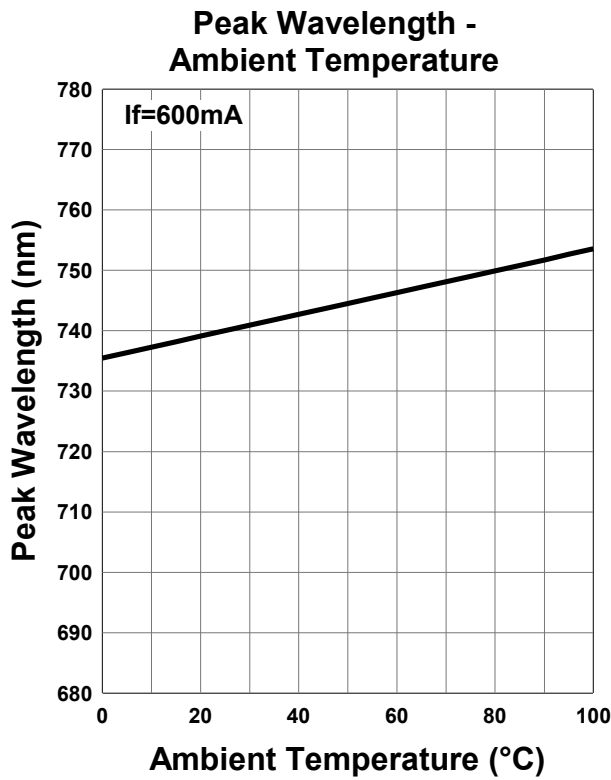
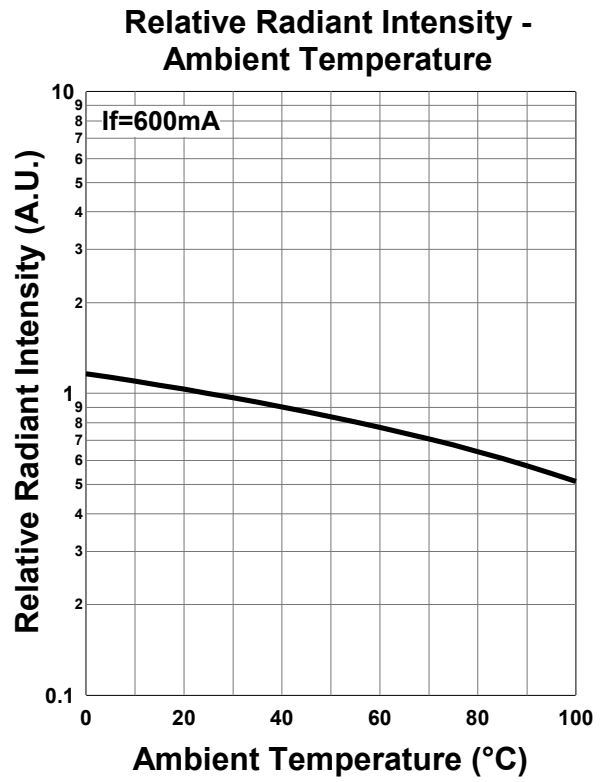
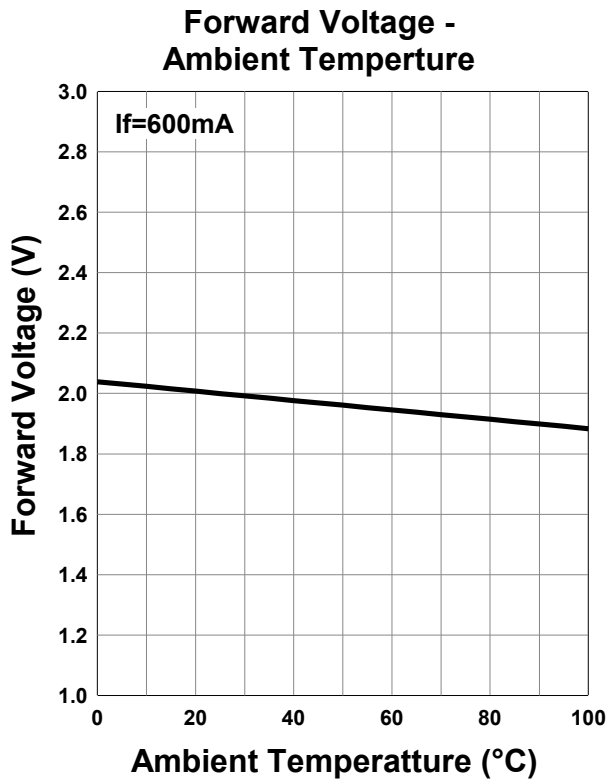

Relative Spectral Emission

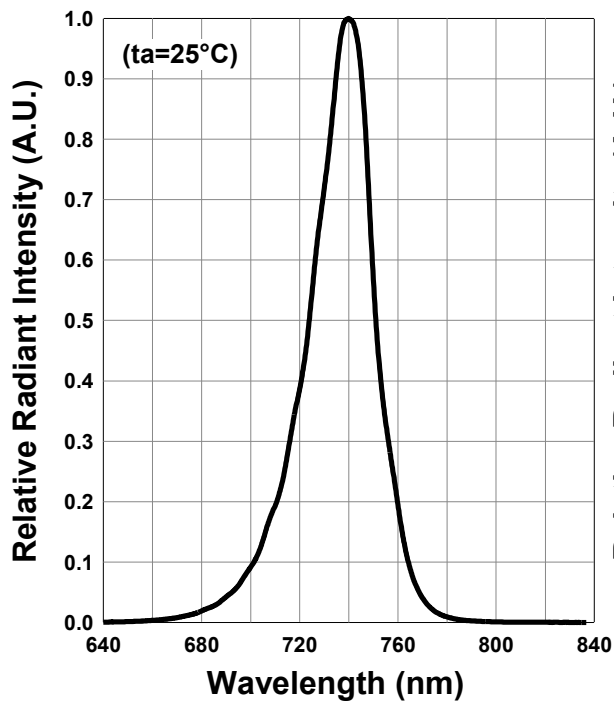

Radiation Characteristics

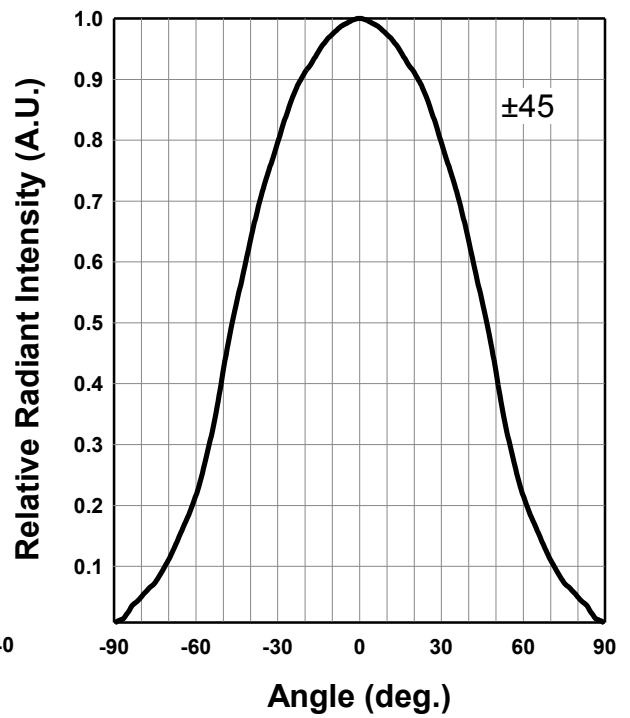

◆ Wrapping

Moisture barrier bag aluminum laminated film with a desiccant to keep out the moisture absorption during the transportation and storage.

SMD LED STORAGE AND HANDLING PRECAUTIONS**<Storage Conditions before Opening a Moisture-Barrier Aluminum Bag>**

- Before opening a moisture-barrier aluminum bag, please store it at <30°C, <60%RH. Please note that the maximum shelf life is 12 months under these conditions.

<Storage Conditions after Opening a Moisture-Barrier Aluminum Bag>

- After opening a moisture-barrier aluminum bag, store the aluminum bag and silica gel in a desiccator.
- After opening the bag, please solder the LEDs within 72 hours in a room with 5 - 30°C, <50%RH.
- Please put any unused, remaining LEDs and silica gel back in the same aluminum bag and then vacuum-seal the bag.
- It is recommended to keep the re-sealed bag in a desiccator at <30%RH.

<Notes about Re-sealing a Moisture-Barrier Aluminum Bag>

- When vacuum-sealing an opened aluminum bag, if you find the moisture-indicator of the silica gel has changed to pink from blue (indicating a relative humidity of 30 % or more), please do not use the unused LEDs, the aluminum bag, or the silica gel.

<Notes about Opening a Re-sealed Moisture-Barrier Aluminum Bag>

- When opening a vacuumed and re-sealed aluminum bag in order to use the remaining LEDs stored in the bag, if you find that the moisture-indicator of the silica has changed to pink, please do not use the LEDs.

※The 72-hour- long floor life does not include the time while LEDs are stored in the moisture-barrier aluminum bag.

However, we strongly recommend to solder the LEDs as soon as possible after opening the aluminum bag.

Disclaimer

Product specifications and data shown in this product catalog are subject to change without notice for the purposes of improving product performance, reliability, design, or otherwise.

Product data and parameters in this catalog are typical values based on reasonably up-to-date measurements. Product data and parameters may vary by user application and over time.

Products shown in this catalog are intended to be used for general electronic equipment. Products are not guaranteed for applications where product malfunction or failure may cause personal injury or death, including but not limited to life-supporting / saving devices, medical devices, safety devices, airplanes, aerospace equipment, automobiles, traffic control systems, and nuclear reactor control systems.

2013.11

Marubeni Corporation

3945 Freedom Circle, Suite 1000, Santa Clara, CA 95054
408-330-0650, 408-330-0655 (Fax), sales@tech-led.com