

EDC375V-1100Z
High Power Top LED

Outer Dimension (Unit:mm)

<Specifications>

- Chip material: AlInGaN
- Chip Dimension: 1000umx1000um
- Chip Number: 1pcs
- Peak Wavelength: 375nm type
- Lead Frame Die: Ceramics
- Lens: Silicone Resin

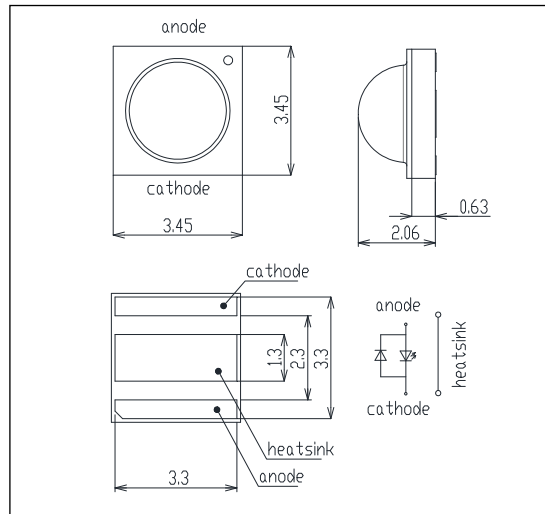

Absolute Maximum Ratings[Tc=25°C]			
Item	Symbol	Maximum Rated Value	Unit
Power Dissipation	PD	2200	mW
Forward Current	IF	500	mA
Pulse Forward Current*	IFP	700	mA
Reverse Voltage	VR	Not designed for reverse operation	V
Thermal Resistance	Rthja	10	K/W
Junction Temperature	Tj	120	°C
Operating Temperature	TOPR	-40 ~ +100	°C
Storage Temperature	TSTG	-40 ~+100	°C
Soldering Temperature**	TSOL	250	°C

* Duty=1% and Pulse Width=10μs

** Soldering condition must be completed within 5 seconds at 250°C

Electro-Optical Characteristics [Tc=25°C]						
Item	Symbol	Condition	Minimum	Typical	Maximum	Unit
Forward Voltage	VF	IF=500mA		3.7	4.5	V
	VFP	IFP=700mA		3.8		
Total Radiated Power*	PO	IF=500mA		560		mW
		IFP=700mA		800		
Radiant Intensity**	IE	IF=500mA		300		mW/sr
		IFP=700mA		430		
Peak Wavelength	λP	IF=500mA	370		380	nm
Half Width	Δλ	IF=500mA		11		nm
Viewing half Angle	θ1/2	IF=100mA		±61		deg
Rise Time	tr	IF=500mA		15		ns
Fall Time	tf	IF=500mA		35		ns

* Measured by S3584-08

** Measured by CIE127-2007 Condition B



Typical Characteristic Curves

Forward Current - Forward Voltage

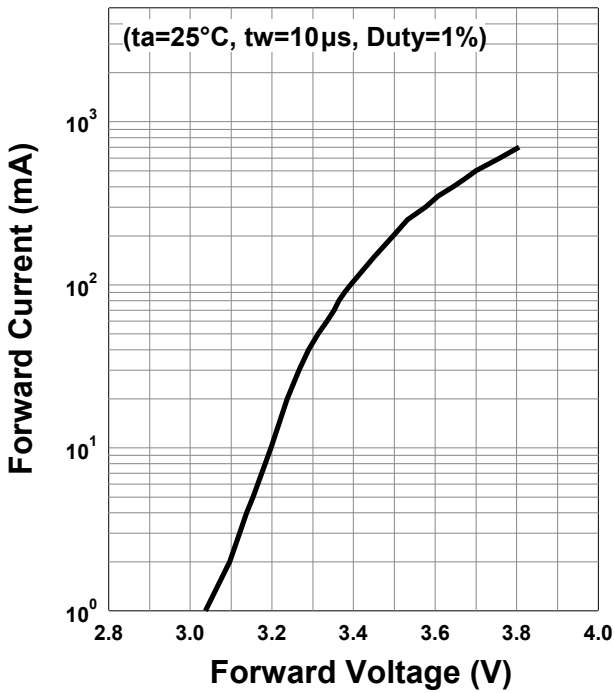

Relative Radiant Intensity - Forward Current

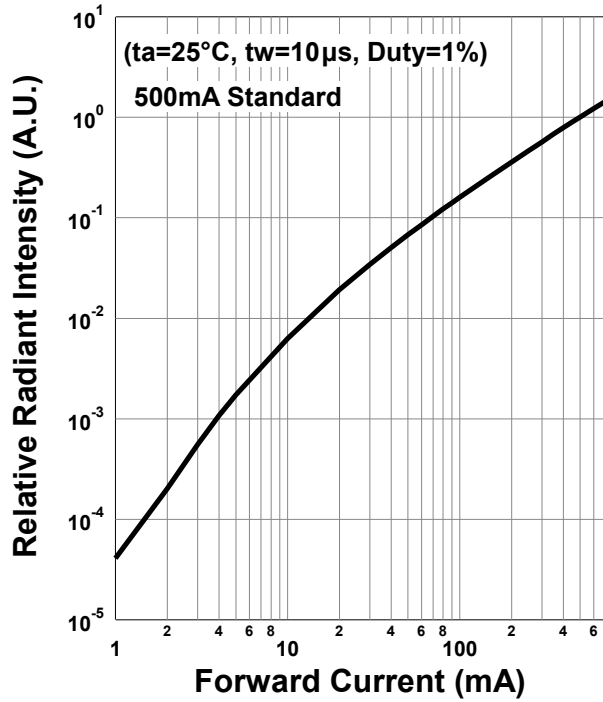

Forward Current - Pulse Duration

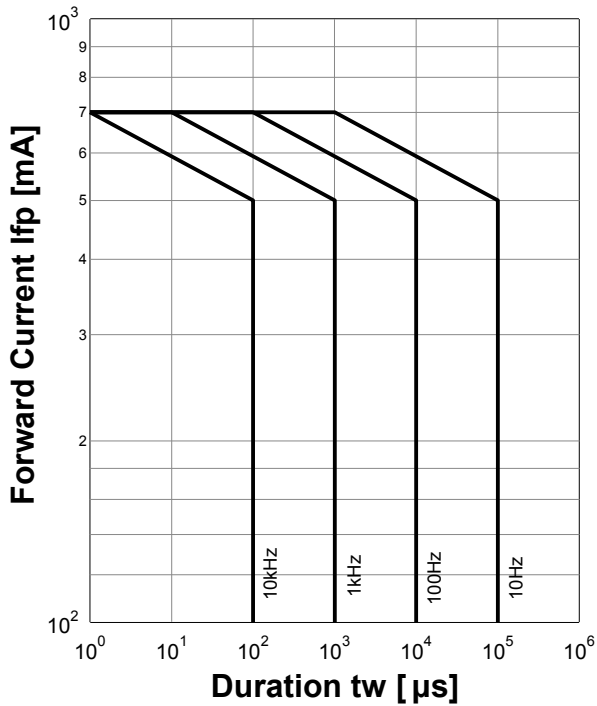

Allowable Forward Current - Ambient Temperature

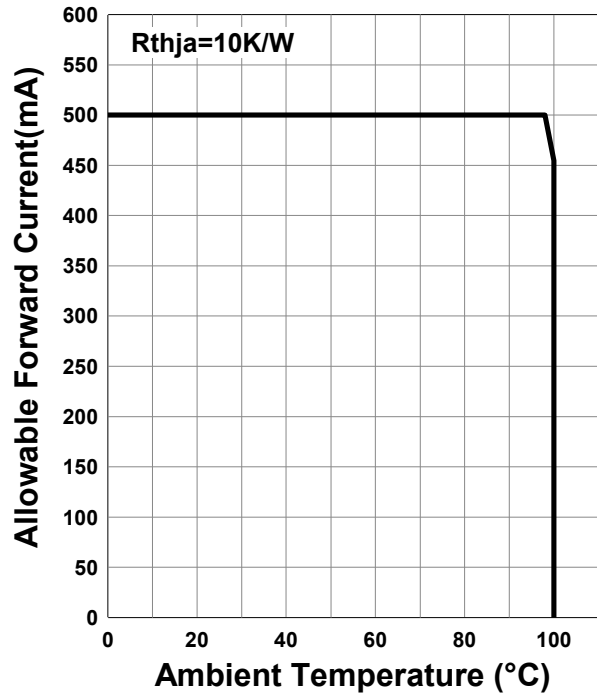

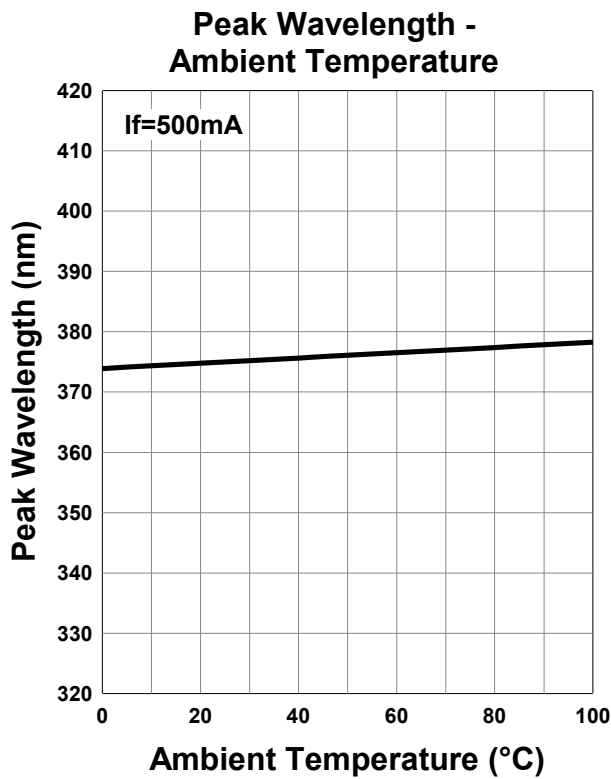
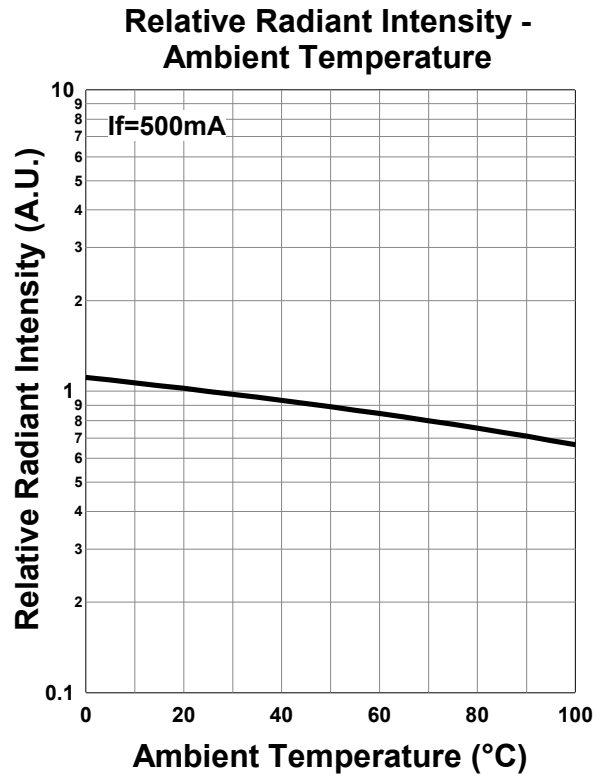
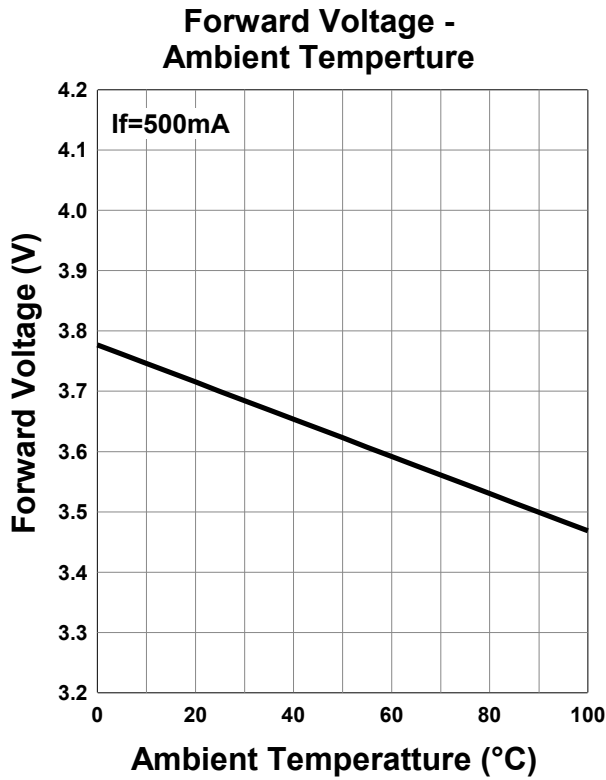

Relative Spectral Emission

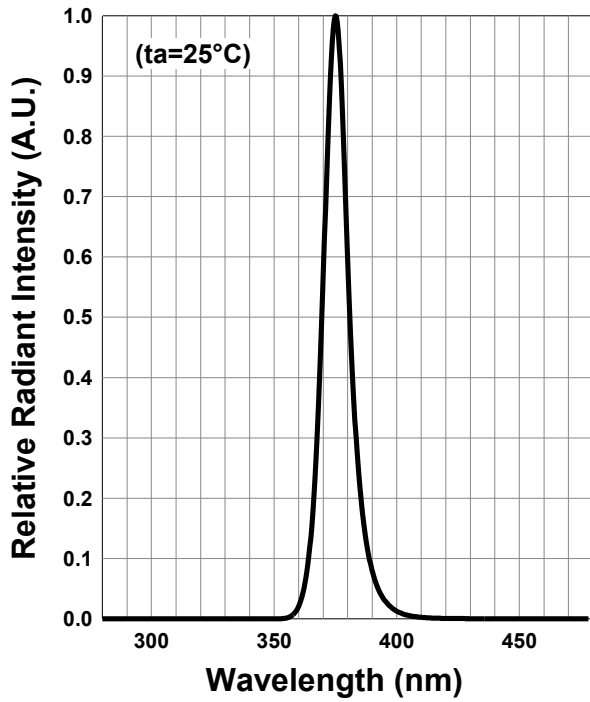

Radiation Characteristics

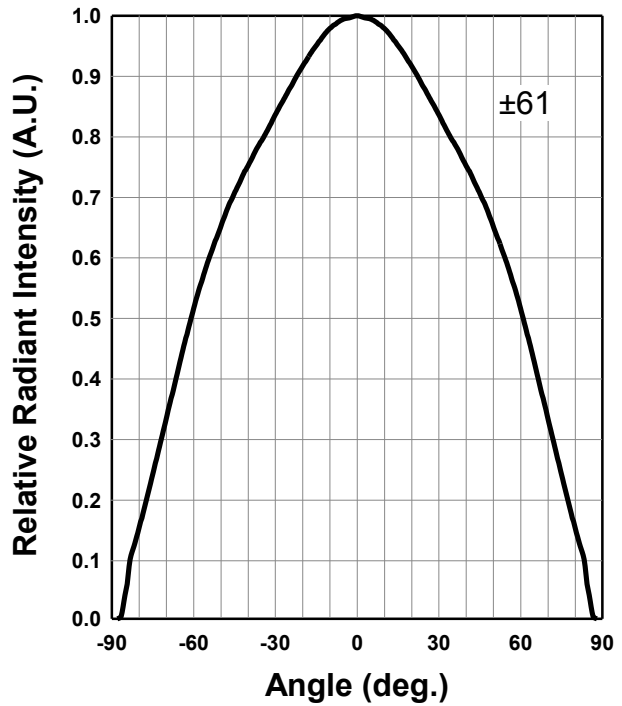

Radiation Characteristics

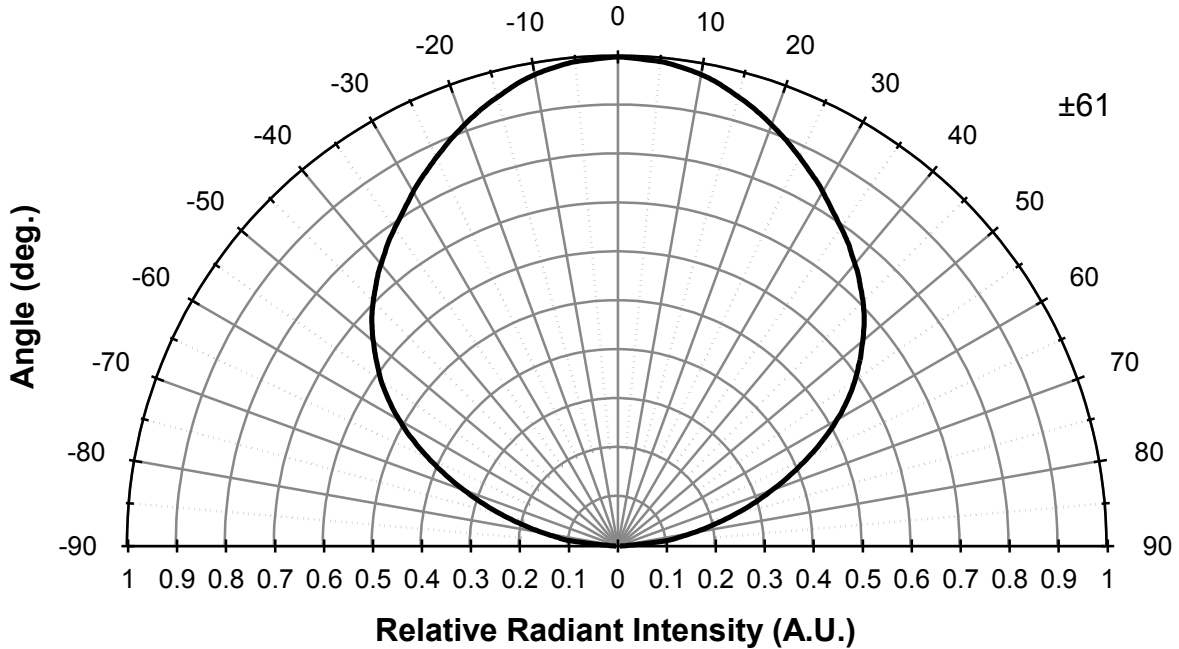

Wrapping

Moisture barrier bag aluminum laminated film with a desiccant to keep out the moisture absorption during the transportation and storage.

SMD LED storage and handling precautions

Storage Conditions before Opening a Moisture-Barrier Aluminum Bag

- Before opening a moisture-barrier aluminum bag, please store it at <30°C, <60%RH.
- Please note that the maximum shelf life is 12 months under these conditions.

Storage Conditions after Opening a Moisture-Barrier Aluminum Bag

- After opening a moisture-barrier aluminum bag, store the aluminum bag and silica gel in a desiccator.
- After opening the bag, please solder the LEDs within 72 hours in a room with 5 - 30°C, <50%RH.
- Please put any unused, remaining LEDs and silica gel back in the same aluminum bag and then vacuum-seal the bag.
- It is recommended to keep the re-sealed bag in a desiccator at <30%RH.
- The 72-hour- long floor life does not include the time while LEDs are stored in the moisture-barrier aluminum bag. However, we strongly recommend to solder the LEDs as soon as possible after opening the aluminum bag

Notes about Re-sealing a Moisture-Barrier Aluminum Bag

- When vacuum-sealing an opened aluminum bag, if you find the moisture-indicator of the silica gel has changed to pink from blue (indicating a relative humidity of 30 % or more), please do not use the unused LEDs, the aluminum bag, or the silica gel.

Notes about Opening a Re-sealed Moisture-Barrier Aluminum Bag

- When opening a vacuumed and re-sealed aluminum bag in order to use the remaining LEDs stored in the bag, if you find that the moisture-indicator of the silica has changed to pink, please do not use the LEDs.

Disclaimer

Product specifications and data shown in this product catalog are subject to change without notice for the purposes of improving product performance, reliability, design, or otherwise.

Product data and parameters in this catalog are typical values based on reasonably up-to-date measurements.

Product data and parameters may vary by user application and over time.

Products shown in this catalog are intended to be used for general electronic equipment. Products are not guaranteed for applications where product malfunction or failure may cause personal injury or death, including but not limited to life-supporting / saving devices, medical devices, safety devices, airplanes, aerospace equipment, automobiles, traffic control systems, and nuclear reactor control systems.