

**SMT970D-23**

High Performance Infrared TOP IR LED with Lens

<Specifications>

1. Product Name: TOP IR LED
2. Type Number: SMT970D-23
3. Chip:
  - Chip Material: AlGaAs
  - Dimension: 350um x 350um
  - Peak Wavelength: 970nm
4. Package
  - Lead Frame Die: Silver Plated
  - Package Resin: PPA Resin
  - Lens: Epoxy Resin
  - Diameter:  $\Phi$ 2.6mm

Outer Dimension (Unit:mm)

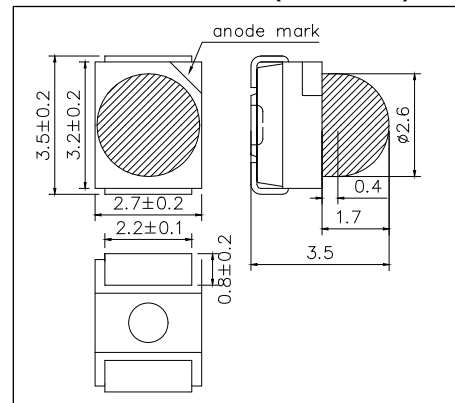

Absolute Maximum Ratings[Ta=25°C]			
Item	Symbol	Maximum Rated Value	Unit
Power Dissipation	PD	180	mW
Forward Current	IF	100	mA
Pulse Forward Current*	IFP	1000	mA
Reverse Voltage	VR	5	V
Thermal Resistance	Rthja	80	K/W
Junction Temperature	Tj	120	°C
Operating Temperature	TOPR	-40 ~ +100	°C
Storage Temperature	TSTG	-40 ~ +100	°C
Soldering Temperature**	TSOL	250	°C

\* Duty=1% and Pulse Width=10us.

\*\*Soldering condition must be completed within 5 second at 250 °C.

Electro-Optical Characteristics [Ta=25°C]						
Item	Symbol	Condition	Minimum	Typical	Maximum	Unit
Forward Voltage	VF	IF=50mA		1.5	(1.8)	V
		IF=100mA t=20ms		1.7		
	VFP	IFP=1A		3.7		
Total Radiated Power*	PO	IF=50mA		30		mW
		IF=100mA t=20ms		60		
		IFP=1A		330		
Radiant Intensity**	IE	IF=50mA		100		mW/sr
		IF=100mA t=20ms		200		
		IFP=1A		1100		
Peak Wavelength	$\lambda$ P	IF=50mA	960	970	980	nm
Half Width	$\Delta\lambda$	IF=50mA		55		nm
Viewing half Angle	$\theta$ 1/2	IF=50mA		$\pm$ 20		deg
Rise Time	tr	IF=50mA		55		ns
Fall Time	tf	IF=50mA		60		ns

\* Measured by S3584-08

\*\* Measured by CIE127-2007 Condition B



**Forward Current - Forward Voltage**

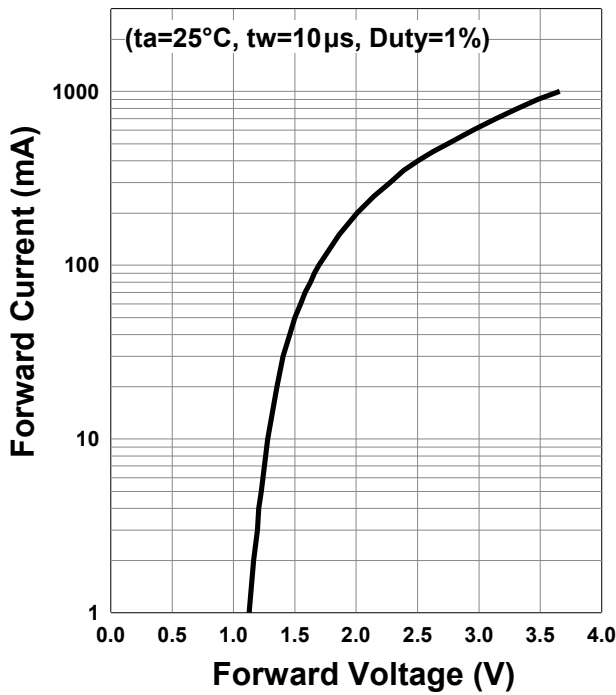

**Relative Radiant Intensity - Forward Current**

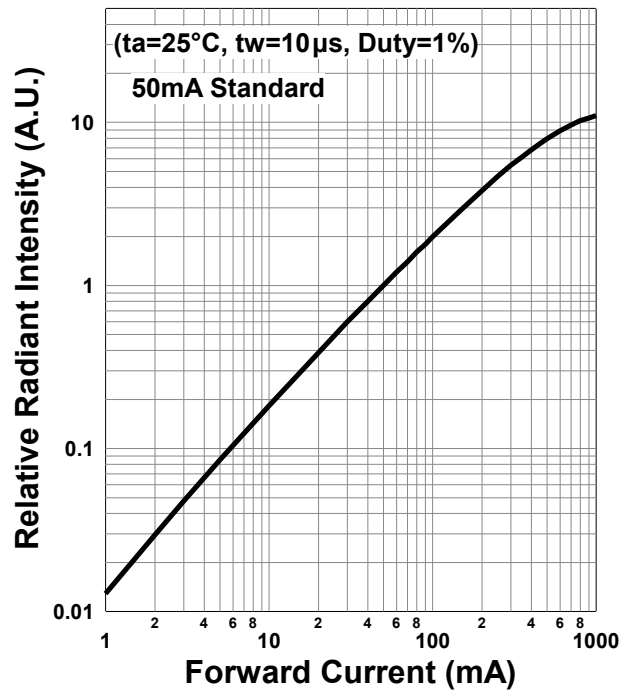

**Forward Current - Pulse Duration**

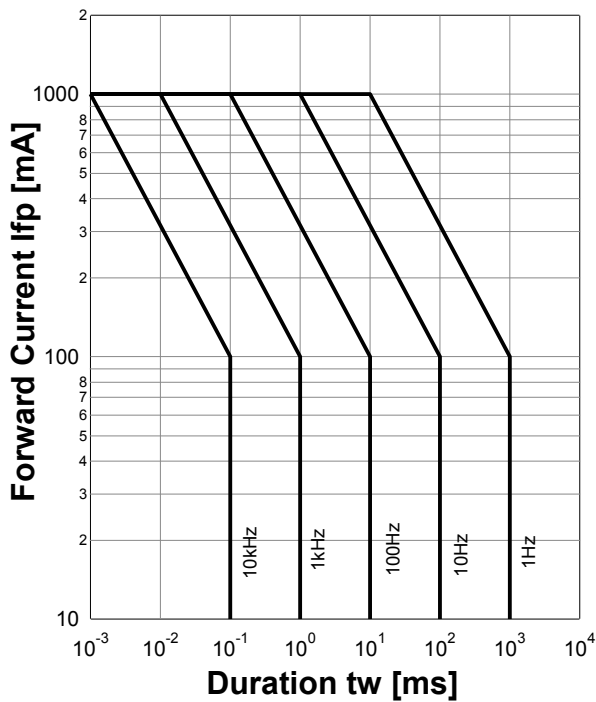

**Allowable Forward Current - Ambient Temperature**

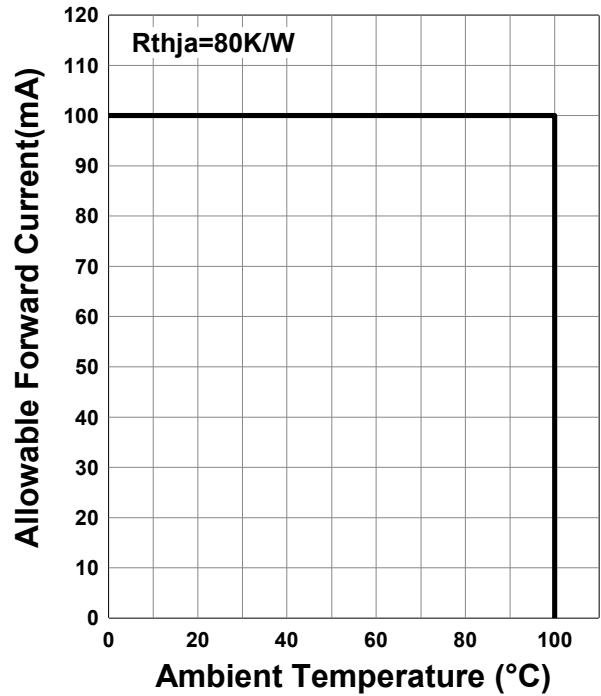

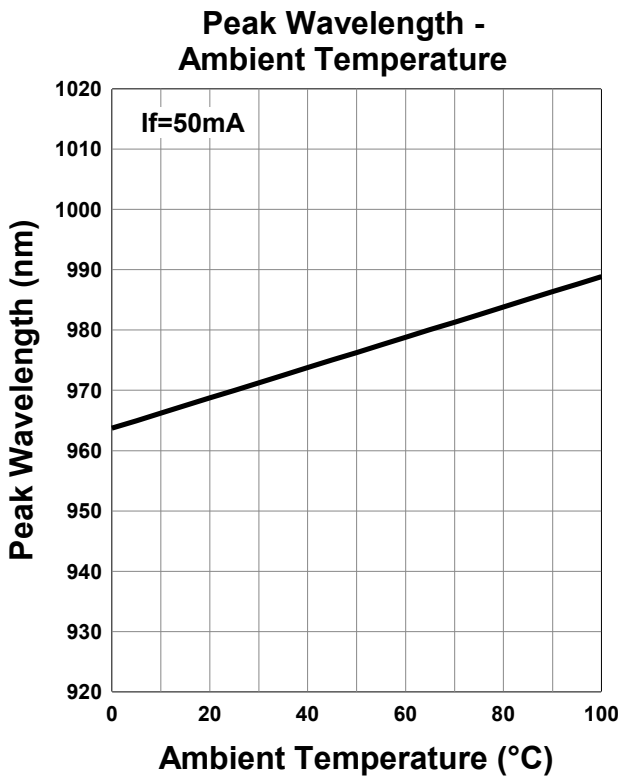
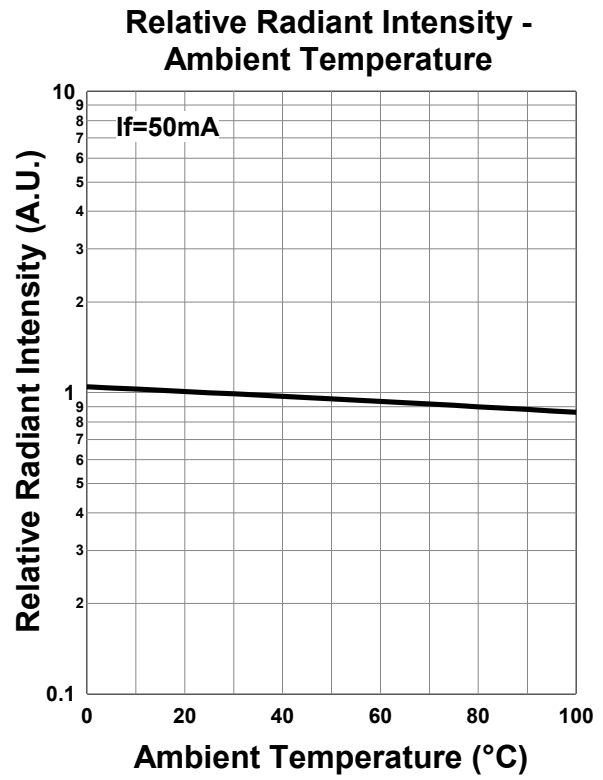
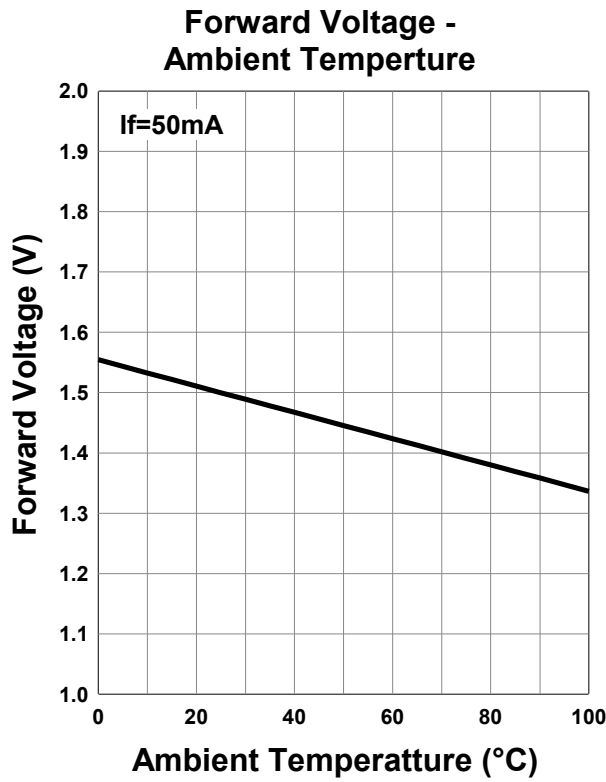

**Relative Spectral Emission**

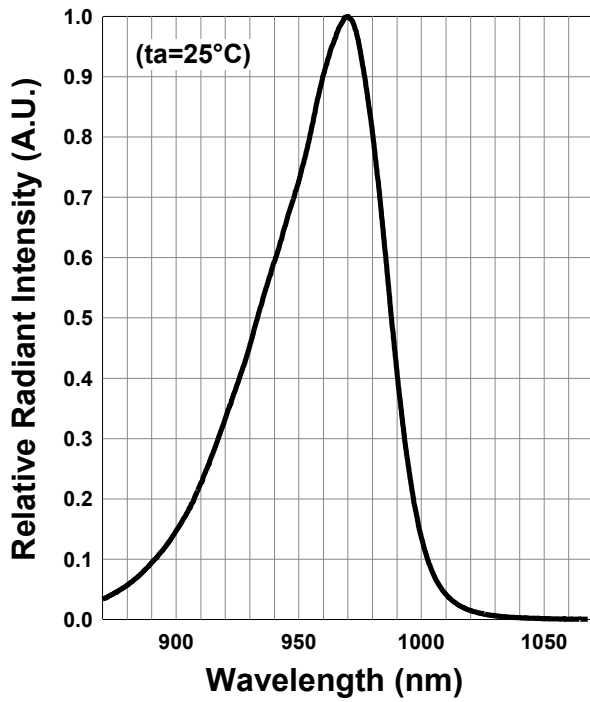

**Radiation Characteristics**

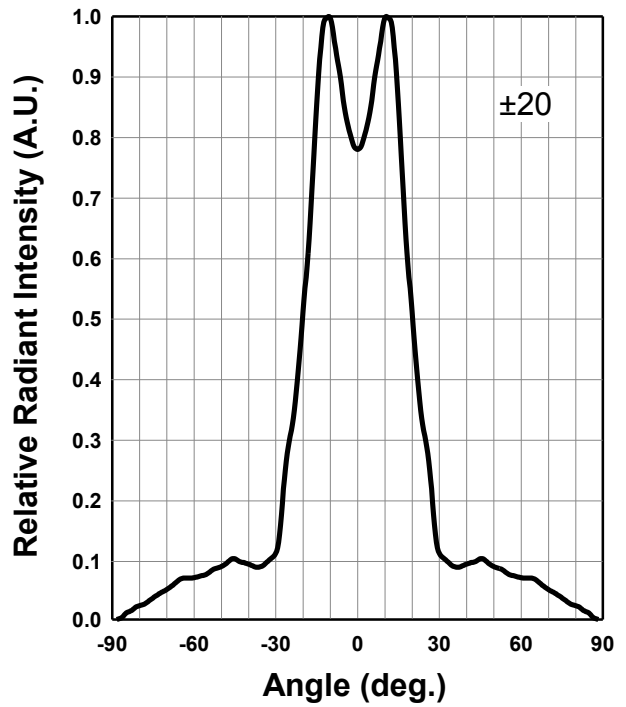

**Radiation Characteristics**

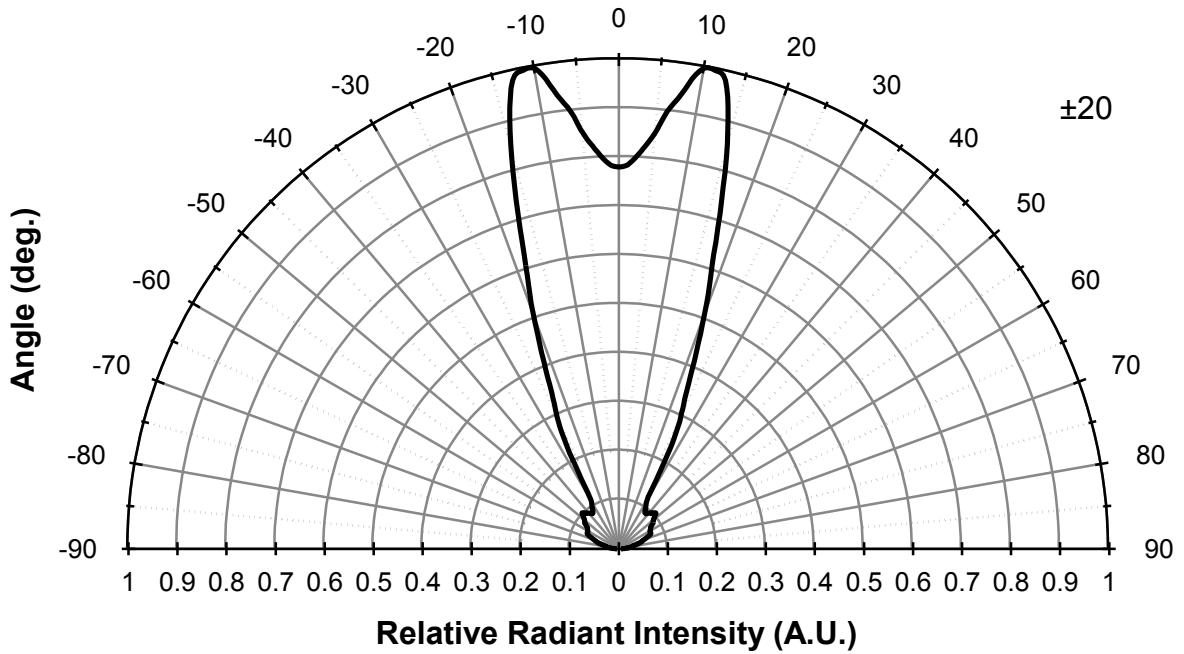

**SMD Application**

IR-Reflow Soldering Profile for lead free soldering

Recommended Land Layout (Unit: mm)

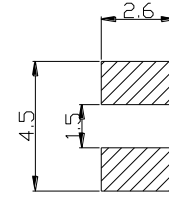
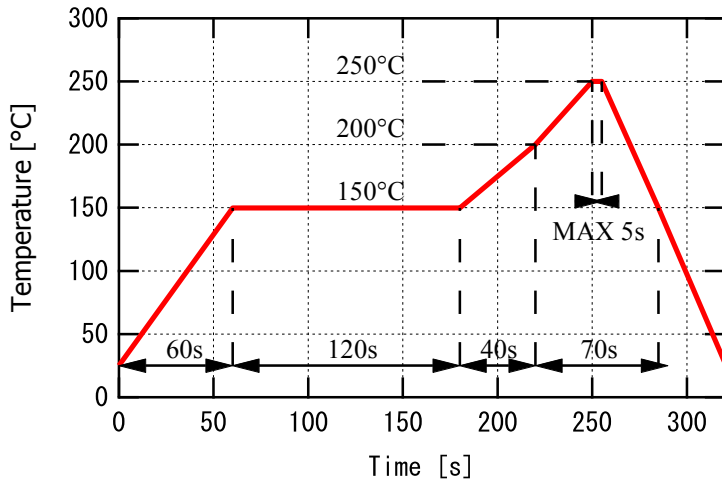

Don't put stress on SMD and a circuit board after soldering.

**SMD Packing**

Tape and Reel Dimensions (Unit: mm)

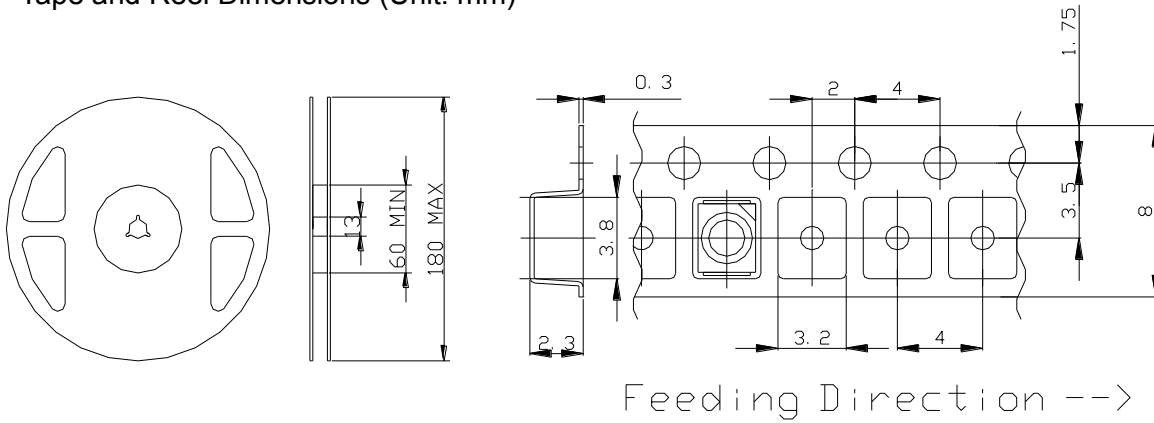

Feeding Direction -->

## Wrapping

Moisture barrier bag aluminum laminated film with a desiccant to keep out the moisture absorption during the transportation and storage.

### SMD LED STORAGE AND HANDLING PRECAUTIONS

#### <Storage Conditions before Opening a Moisture-Barrier Aluminum Bag>

- Before opening a moisture-barrier aluminum bag, please store it at <30°C, <60%RH. Please note that the maximum shelf life is 12 months under these conditions.

#### <Storage Conditions after Opening a Moisture-Barrier Aluminum Bag>

- After opening a moisture-barrier aluminum bag, store the aluminum bag and silica gel in a desiccator.
- After opening the bag, please solder the LEDs within 72 hours in a room with 5 - 30°C, <50%RH.
- Please put any unused, remaining LEDs and silica gel back in the same aluminum bag and then vacuum-seal the bag.
- It is recommended to keep the re-sealed bag in a desiccator at <30%RH.

#### <Notes about Re-sealing a Moisture-Barrier Aluminum Bag>

- When vacuum-sealing an opened aluminum bag, if you find the moisture-indicator of the silica gel has changed to pink from blue (indicating a relative humidity of 30 % or more), please do not use the unused LEDs, the aluminum bag, or the silica gel.

#### <Notes about Opening a Re-sealed Moisture-Barrier Aluminum Bag>

- When opening a vacuumed and re-sealed aluminum bag in order to use the remaining LEDs stored in the bag, if you find that the moisture-indicator of the silica has changed to pink, please do not use the LEDs.

※The 72-hour- long floor life does not include the time while LEDs are stored in the moisture-barrier aluminum bag.

However, we strongly recommend to solder the LEDs as soon as possible after opening the aluminum bag.

**Disclaimer**

Product specifications and data shown in this product catalog are subject to change without notice for the purposes of improving product performance, reliability, design, or otherwise.

Product data and parameters in this catalog are typical values based on reasonably up-to-date measurements. Product data and parameters may vary by user application and over time.

Products shown in this catalog are intended to be used for general electronic equipment. Products are not guaranteed for applications where product malfunction or failure may cause personal injury or death, including but not limited to life-supporting / saving devices, medical devices, safety devices, airplanes, aerospace equipment, automobiles, traffic control systems, and nuclear reactor control systems.

2014.12