

SMT660N/805/940
High Performance Multi-Color TOP LED

<Specifications>

- Chip Material: AlGaInP/AlGaAs/AlGaAs
- Chip Dimension: 400um x 400um
- Number of Chips: 3pcs
- Peak Wavelength: 660/805/940nm typ.
- Lead Frame Die: Silver Plated
- Package Resin: PA6T
- Lens: Silicone or Epoxy Resin

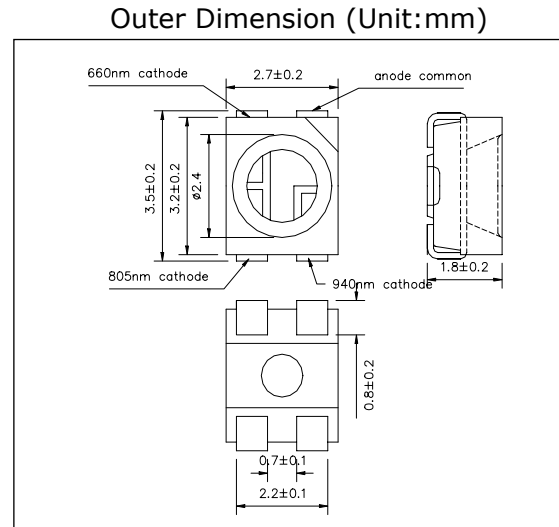

Absolute Maximum Ratings[Tc=25°C]					
Item	Symbol	Raitings			Unit
		660nm	805nm	940nm	
Power Dissipation	PD	120	200	140	mW
Forward Current	IF	50	100	100	mA
Pulse Forward Current*	IFP	300	500	1000	mA
Reverse Voltage	VR	5			V
Thermal Resistance	Rthja	80			K/W
Junction Temperature	Tj	120			°C
Operating Temperature	TOPR	-40 ~ +100			°C
Storage Temperature	TSTG	-40 ~ +100			°C
Soldering Temperature**	TSOL	250			°C

* Duty=1% and Pulse width=10µs

** Soldering condition must be completed within 5 second at 250°C.

Electro-Optical Characteristics [Tc=25°C]												
Item	Symbol	Condition	Min			Typ			Max			Unit
			660	805	940	660	805	940	660	805	940	
Forward Voltage	VF	IF=20mA				1.9	1.6	1.2	2.5	1.8	1.4	V
	VFP	IFP=300mA				3.4	2.9	2.2				
Total Radiated Power*	PO	IF=20mA				11	7.8	4.2				mW
		IFP=300mA				150	190	190				
Peak Wavelength	λP	IF=20mA	650	795	930				670	815	950	nm
Half Width	Δλ	IF=20mA				16	29	50				nm
Rise Time	tr	IF=20mA				30	40	200				ns
Fall Time	tf	IF=20mA				30	40	800				ns

* Measured by S3584-08



Typical Characteristic Curves

660nm

Forward Current - Forward Voltage

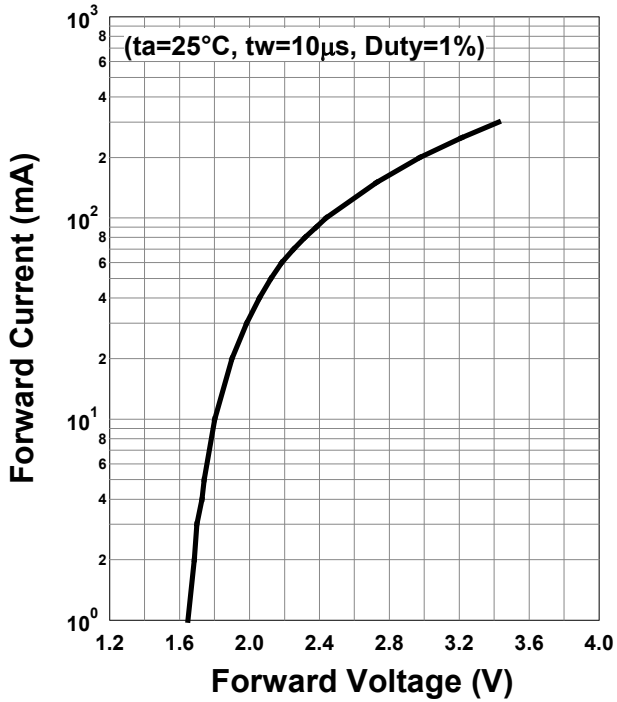

Relative Radiant Intensity - Forward Current

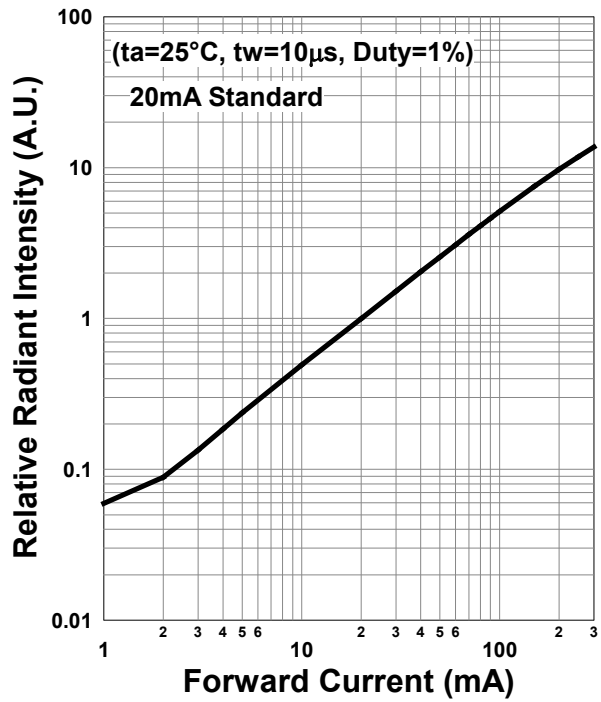

Forward Current - Pulse Duration

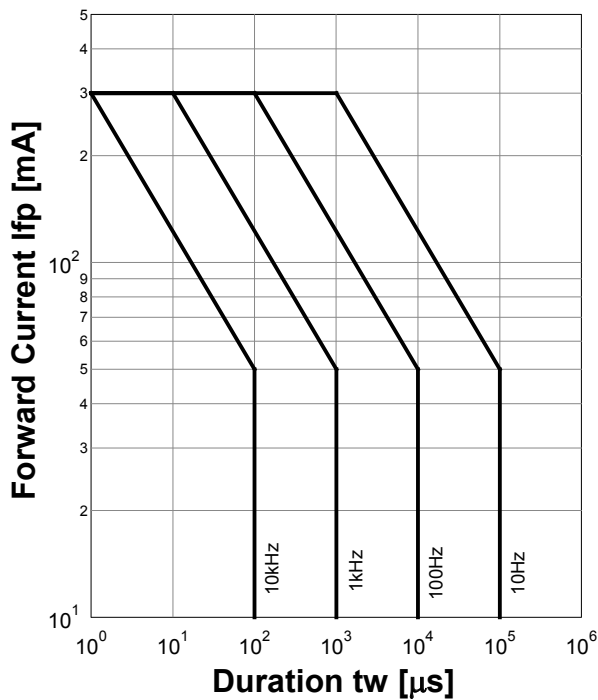

Allowable Forward Current - Ambient Temperature

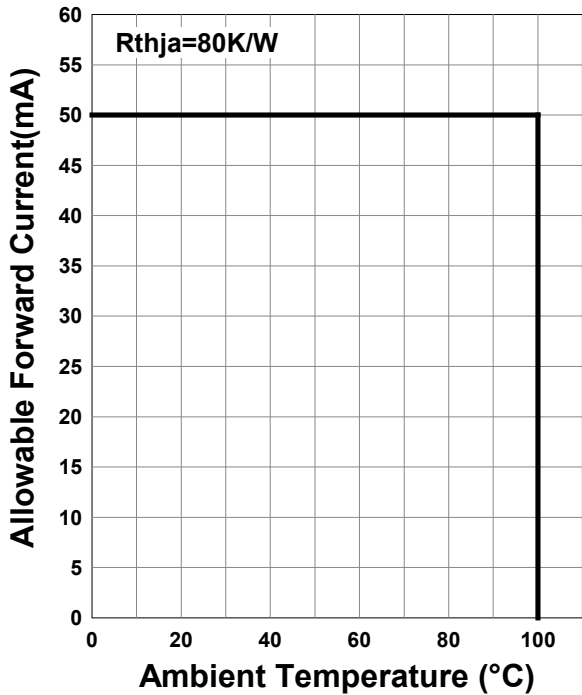

660nm

Forward Voltage - Ambient Temperature

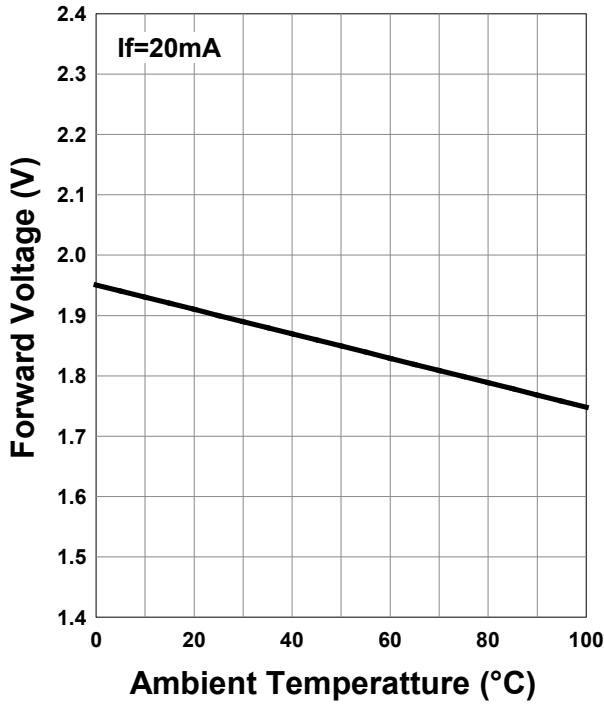

Relative Radiant Intensity - Ambient Temperature

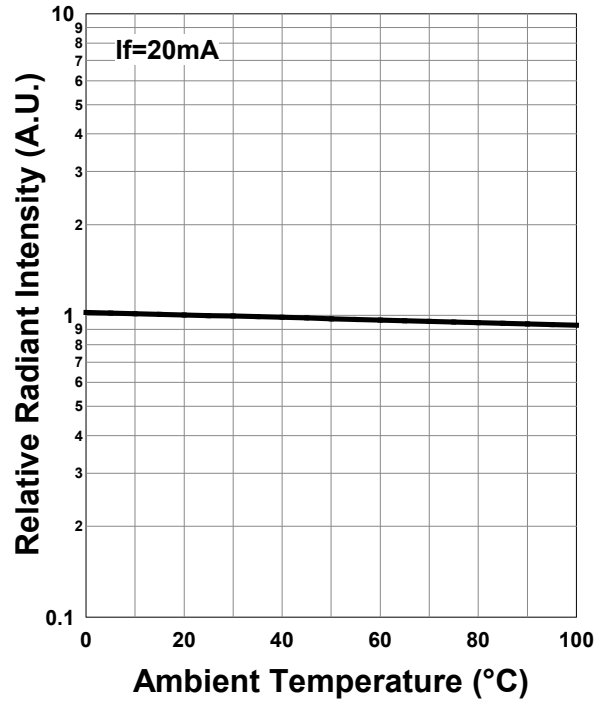

Peak Wavelength - Ambient Temperature

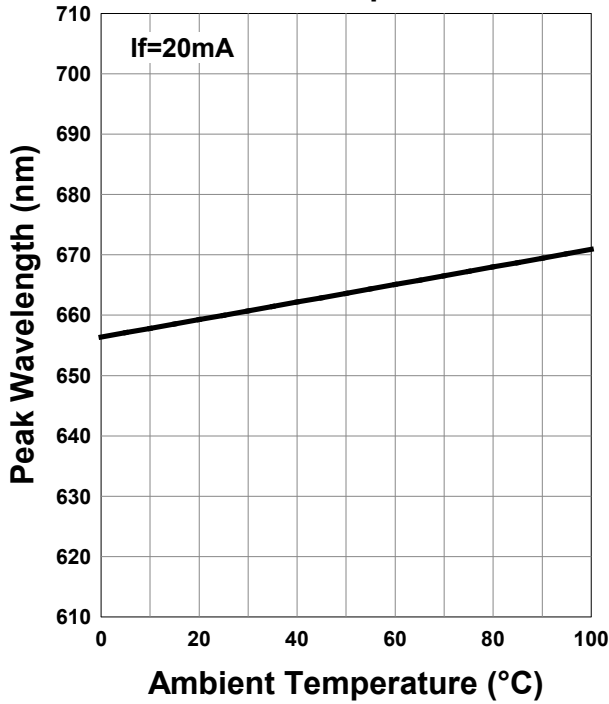

Relative Spectral Emission

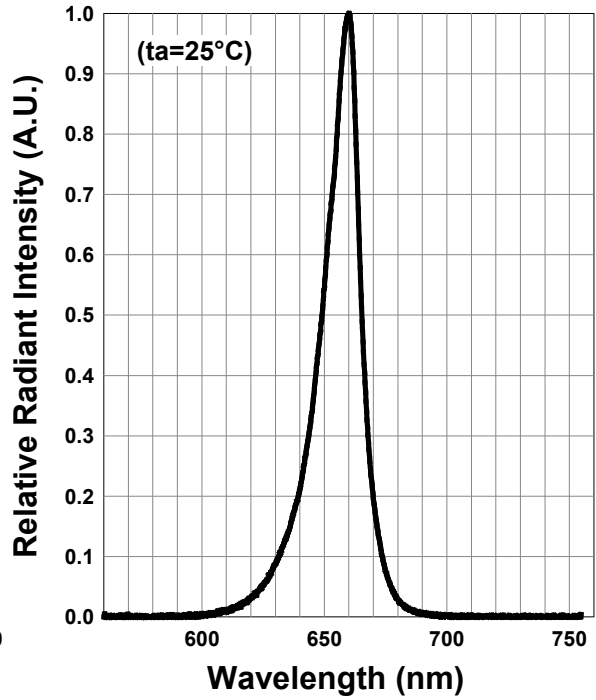

Typical Characteristic Curves
805nm

Forward Current - Forward Voltage

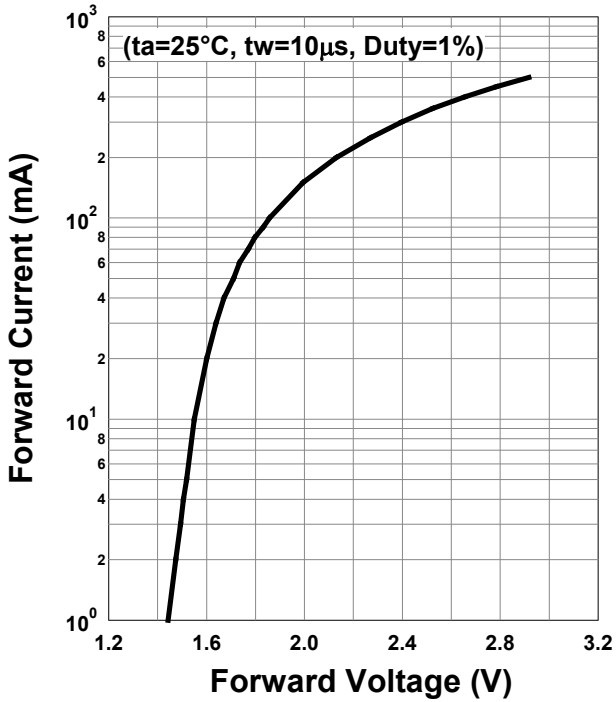

Relative Radiant Intensity - Forward Current

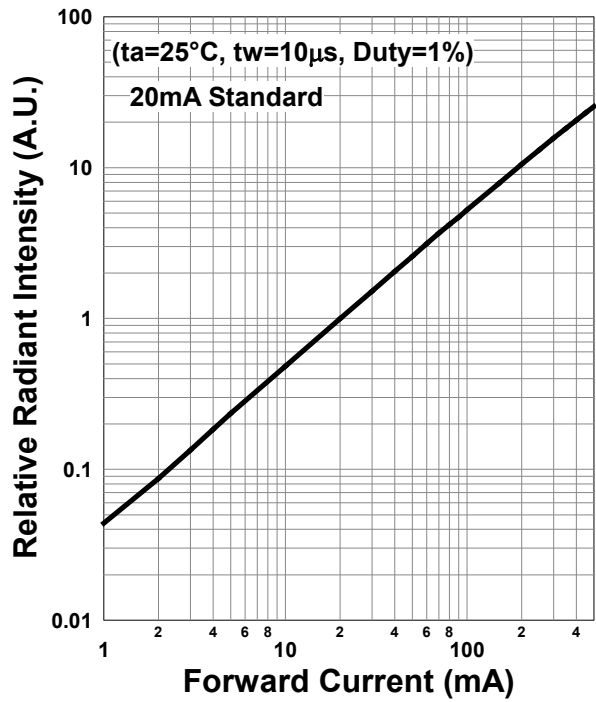

Forward Current - Pulse Duration

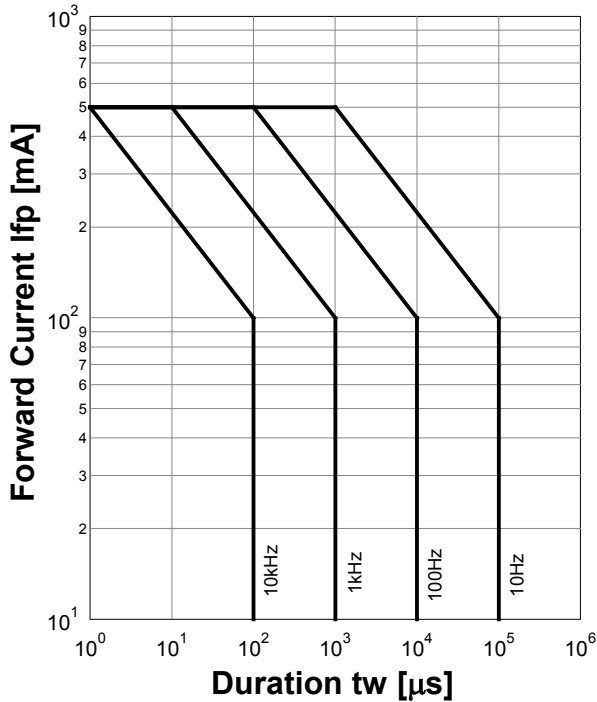

Allowable Forward Current - Ambient Temperature

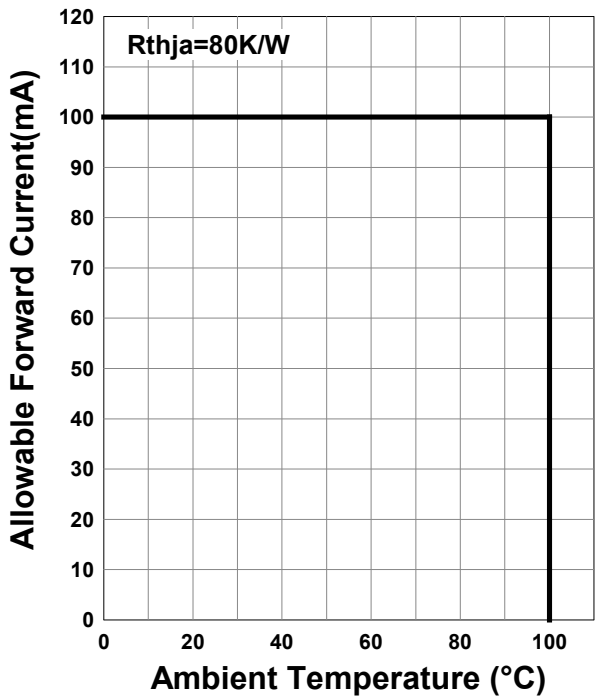

805nm

Forward Voltage - Ambient Temperature

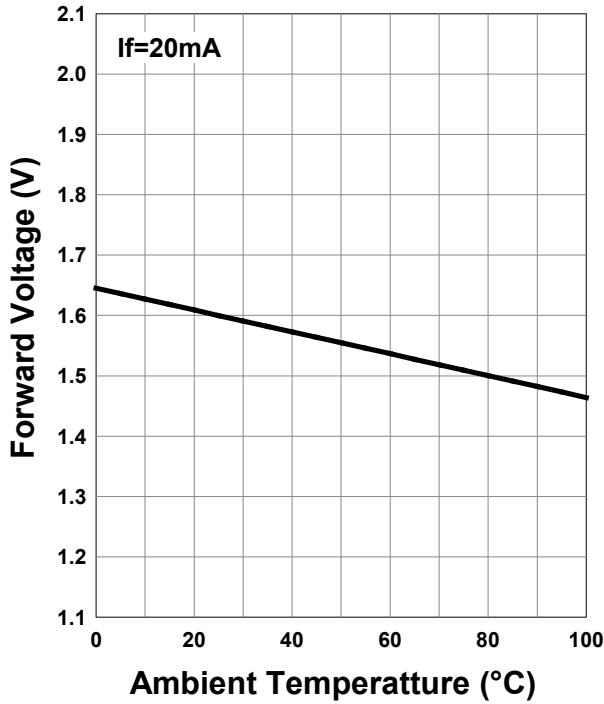

Relative Radiant Intensity - Ambient Temperature

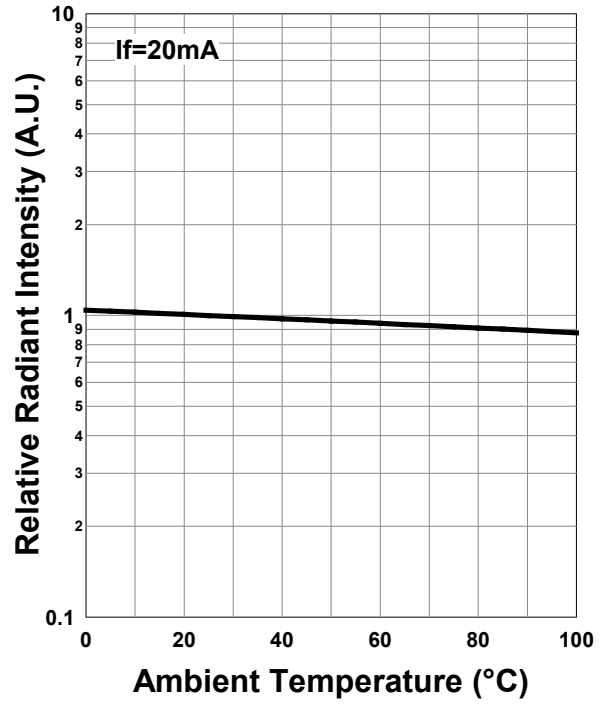

Peak Wavelength - Ambient Temperature

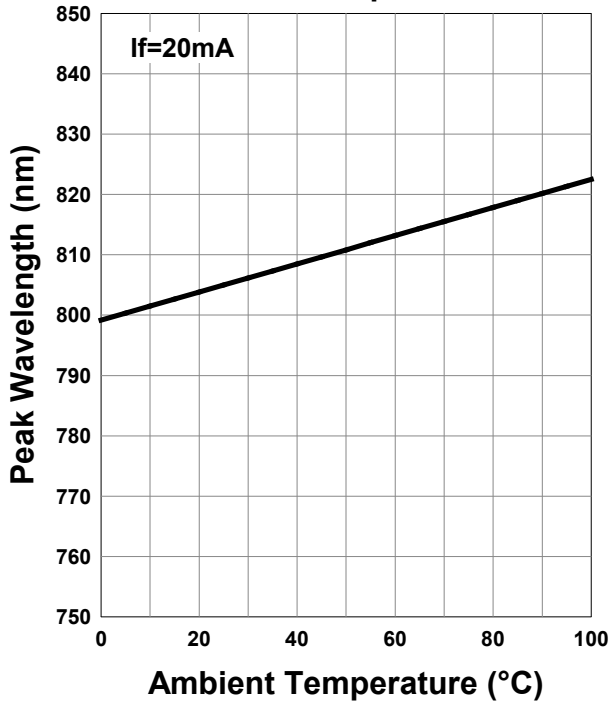

Relative Spectral Emission

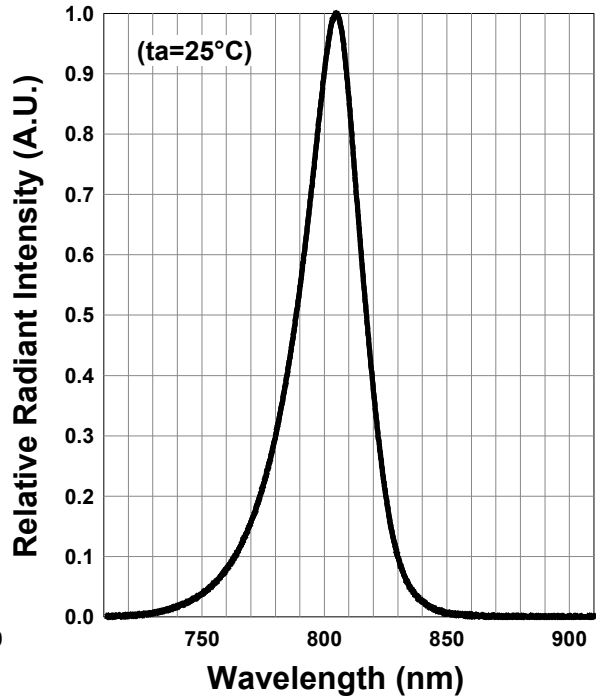

Typical Characteristic Curves

940nm

Forward Current - Forward Voltage

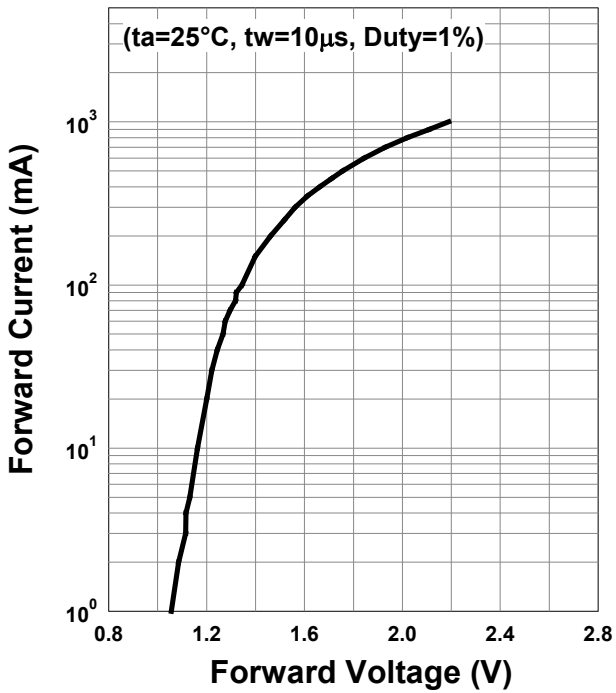

Relative Radiant Intensity - Forward Current

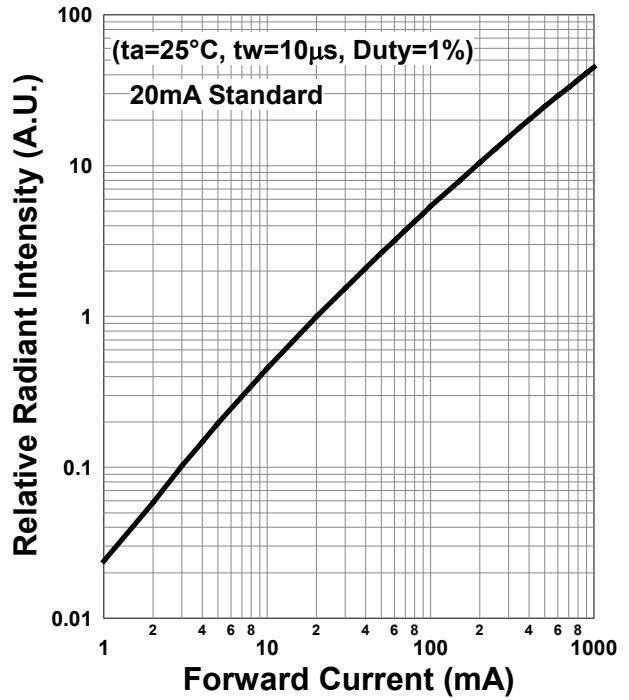

Forward Current - Pulse Duration

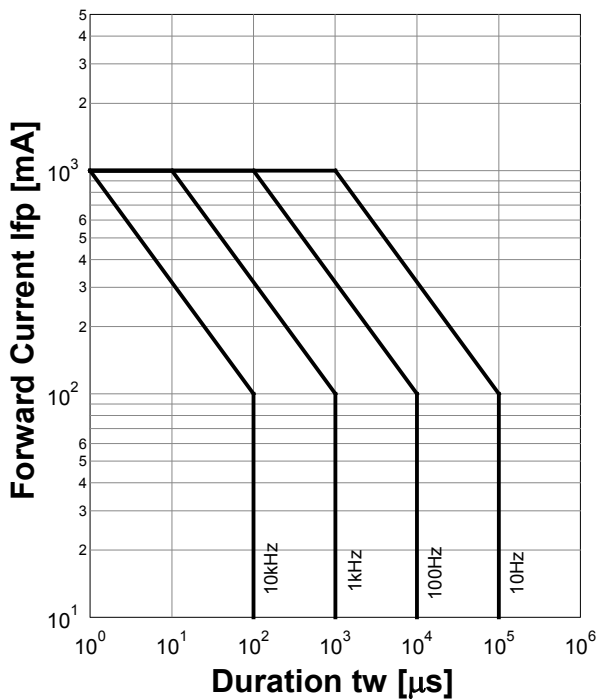

Allowable Forward Current - Ambient Temperature

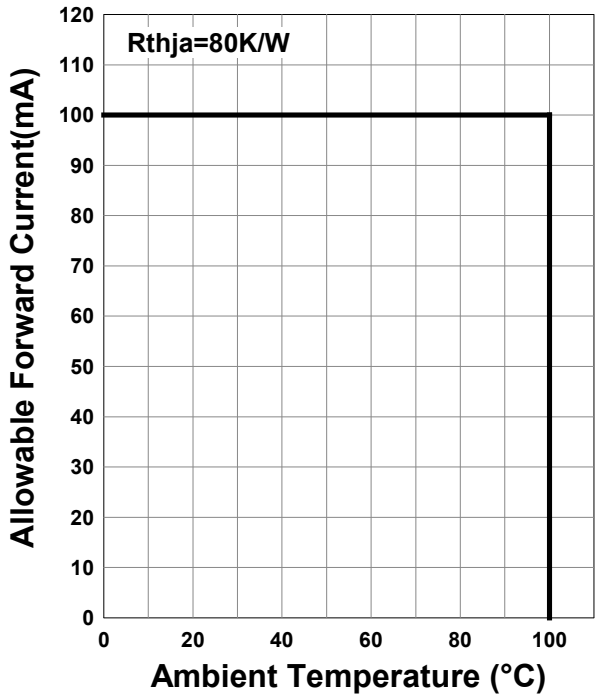

940nm

Forward Voltage - Ambient Temperature

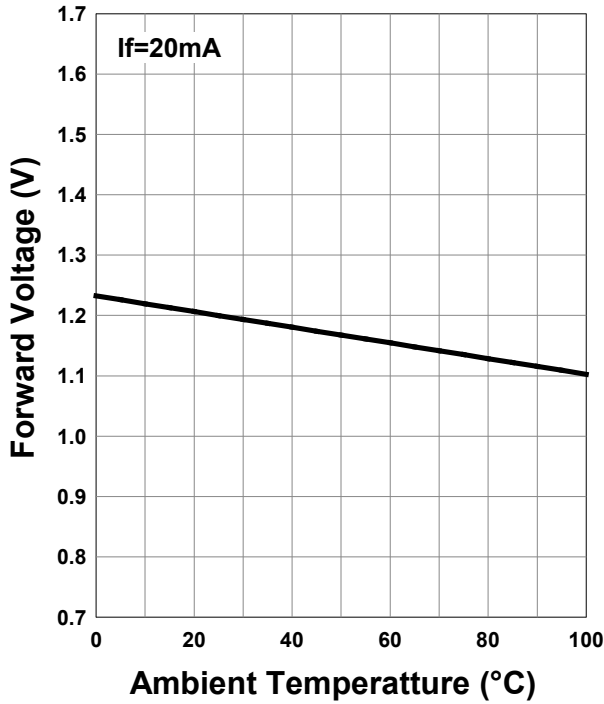

Relative Radiant Intensity - Ambient Temperature

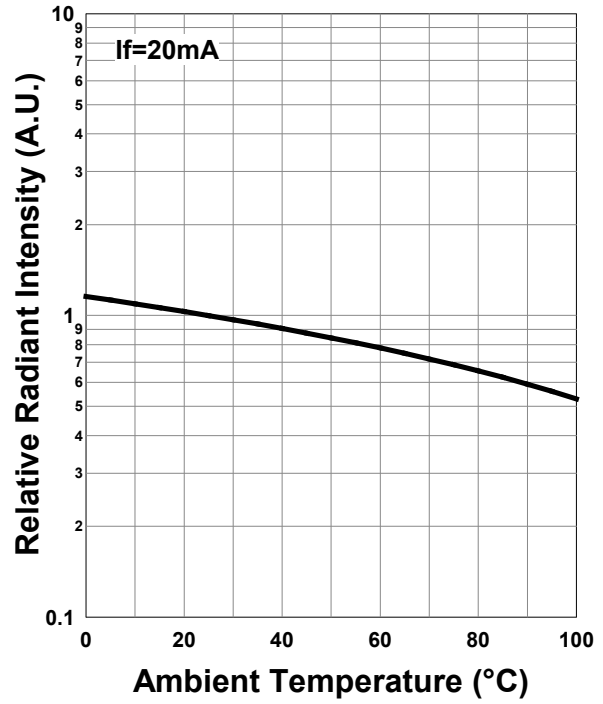

Peak Wavelength - Ambient Temperature

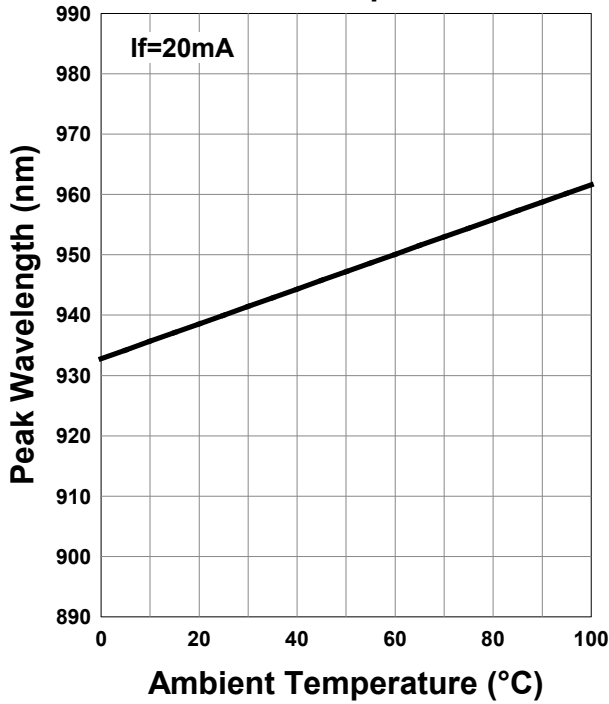

Relative Spectral Emission

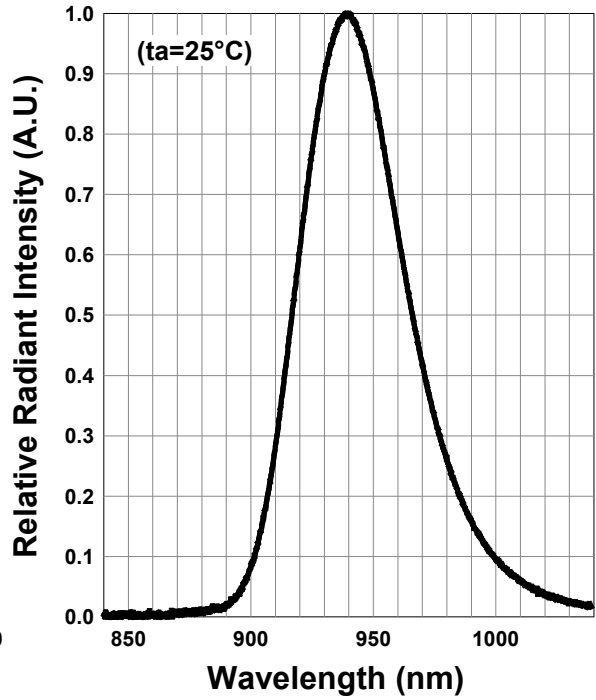

Recommended reflow soldering profile

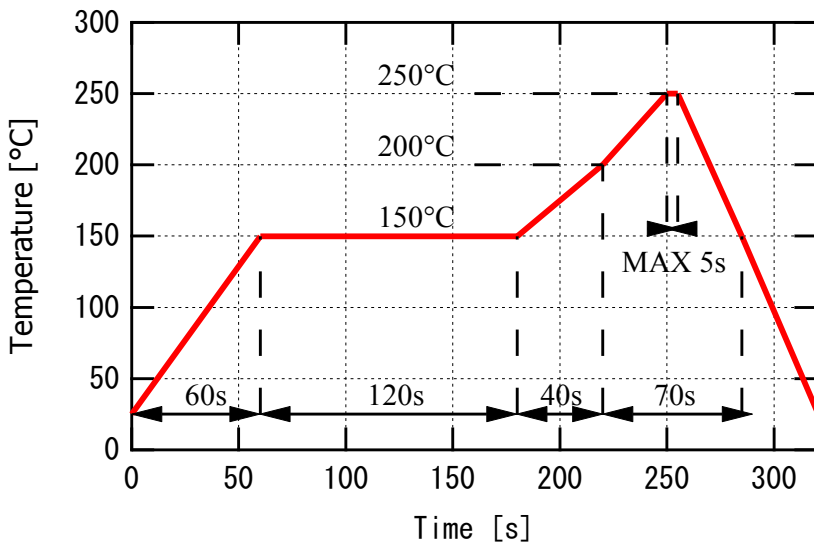

Don't put stress on SMD and a circuit board after soldering

**Recommended Land Layout
(Unit: mm)**

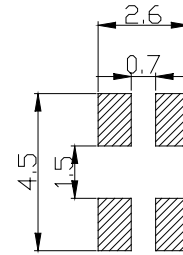

SMD Packing

Tape and Reel Dimensions (Unit: mm)

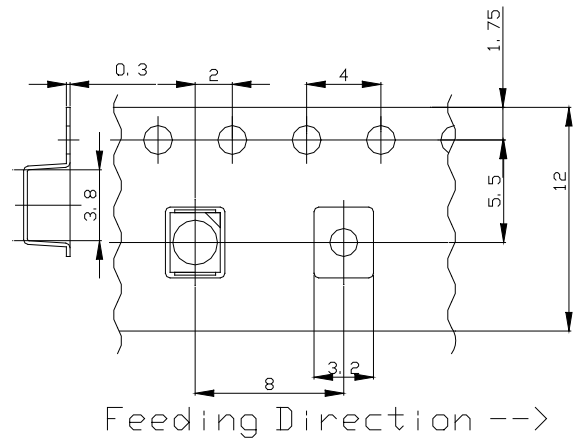
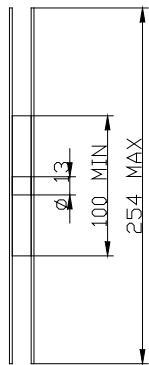
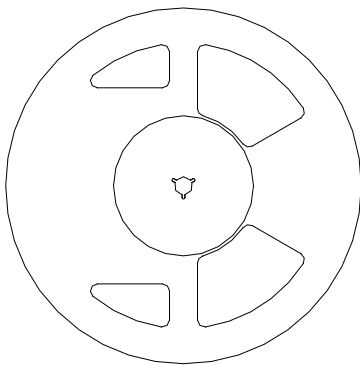

Wrapping

Moisture barrier bag aluminum laminated film with a desiccant to keep out the moisture absorption during the transportation and storage.

SMD LED storage and handling precautions

Storage Conditions before Opening a Moisture-Barrier Aluminum Bag

- Before opening a moisture-barrier aluminum bag, please store it at <30°C, <60%RH.
- Please note that the maximum shelf life is 12 months under these conditions.

Storage Conditions after Opening a Moisture-Barrier Aluminum Bag

- After opening a moisture-barrier aluminum bag, store the aluminum bag and silica gel in a desiccator.
- After opening the bag, please solder the LEDs within 72 hours in a room with 5 - 30°C, <50%RH.
- Please put any unused, remaining LEDs and silica gel back in the same aluminum bag and then vacuum-seal the bag.
- It is recommended to keep the re-sealed bag in a desiccator at <30%RH.
- The 72-hour- long floor life does not include the time while LEDs are stored in the moisture-barrier aluminum bag. However, we strongly recommend to solder the LEDs as soon as possible after opening the aluminum bag

Notes about Re-sealing a Moisture-Barrier Aluminum Bag

- When vacuum-sealing an opened aluminum bag, if you find the moisture-indicator of the silica gel has changed to pink from blue (indicating a relative humidity of 30 % or more), please do not use the unused LEDs, the aluminum bag, or the silica gel.

Notes about Opening a Re-sealed Moisture-Barrier Aluminum Bag

- When opening a vacuumed and re-sealed aluminum bag in order to use the remaining LEDs stored in the bag, if you find that the moisture-indicator of the silica has changed to pink, please do not use the LEDs.

Disclaimer

Product specifications and data shown in this product catalog are subject to change without notice for the purposes of improving product performance, reliability, design, or otherwise.

Product data and parameters in this catalog are typical values based on reasonably up-to-date measurements.

Product data and parameters may vary by user application and over time.

Products shown in this catalog are intended to be used for general electronic equipment. Products are not guaranteed for applications where product malfunction or failure may cause personal injury or death, including but not limited to life-supporting / saving devices, medical devices, safety devices, airplanes, aerospace equipment, automobiles, traffic control systems, and nuclear reactor control systems.