

SMBB630-1100 High Power Top LED

SMBB630-1100 is an AlGaInP LED mounted on copper heatsink with a 5x5 mm package. These devices are available to be operated and 300mW at I_{FP}=1A.

◆ Specifications

- 1) Product Name High Power Top LED
- 2) Type No. SMBB630-1100
- 3) Chip
- (1) Chip Material AlGaInP
- (2) Chip Dimension 1000um*1000um
- (3) Chip Number 1pce
- (4) Peak Wavelength 630nm typ.
- 4) Package
- (1) Lead Frame Die Silver Plated on Copper
- (2) Package Resin PPA Resin
- (3) Lens Epoxy Resin

◆ Outer dimension (Unit: mm)

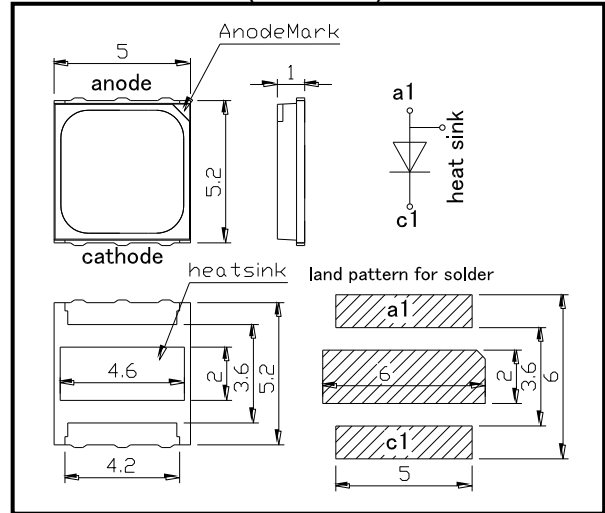

◆ Absolute Maximum Ratings

Item	Symbol	Maximum Rated Value	Unit	Ambient Temperature
Power Dissipation	P _D	1600	mW	T _a =25°C
Forward Current	I _F	350	mA	T _a =25°C
Pulse Forward Current	I _{FP}	1000	mA	T _a =25°C
Reverse Voltage	V _R	5	V	T _a =25°C
Thermal Resistance	R _{thja}	10	K/W	
Junction Temperature	T _j	100	°C	
Operating Temperature	T _{OPR}	-40 ~ +85	°C	
Storage Temperature	T _{STG}	-40 ~ +100	°C	
Soldering Temperature	T _{SOL}	250	°C	

‡Pulse Forward Current condition: Duty=1% and Pulse Width=10us.

‡Soldering condition: Soldering condition must be completed within 5 seconds at 250°C

◆ Electro-Optical Characteristics [T_a=25°C]

Item	Symbol	Condition	Minimum	Typical	Maximum	Unit
Forward Voltage	V _F	I _F =350mA		2.2	2.7	V
	V _{FP}	I _{FP} =1A		2.6		
Radiated Power	P _O	I _F =350mA		250		mW
		I _{FP} =1A		700		
Radiant Intensity	I _E	I _F =350mA		70		mW/sr
		I _{FP} =1A		-		
Peak Wavelength	λ _P	I _F =350mA	620	630	640	nm
Half Width	Δλ	I _F =350mA		16		nm
Viewing Half Angle	θ 1/2	I _F =100mA		±62		deg.
Rise Time	t _r	I _F =350mA		170		ns
Fall Time	t _f	I _F =350mA		140		ns

‡Radiated Power is measured by S3584-08.

‡Radiant Intensity is measured by Tektronix J-6512.

Forward Current - Forward Voltage

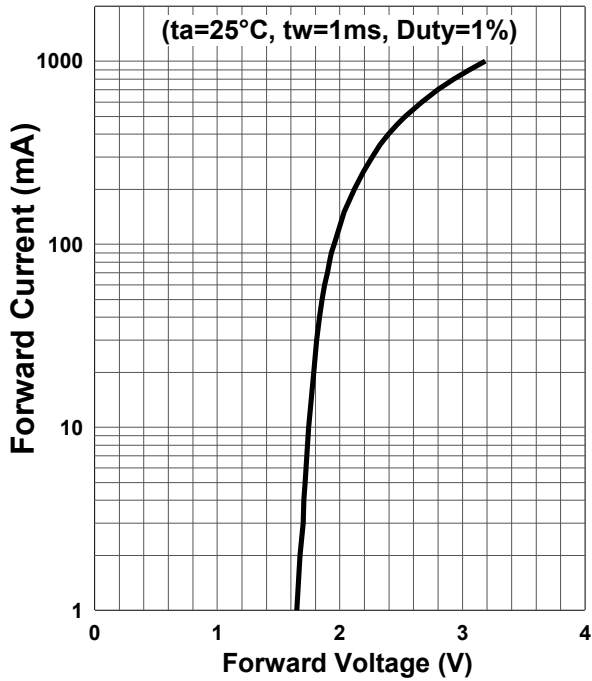

Relative Radiant Intensity - Forward Current

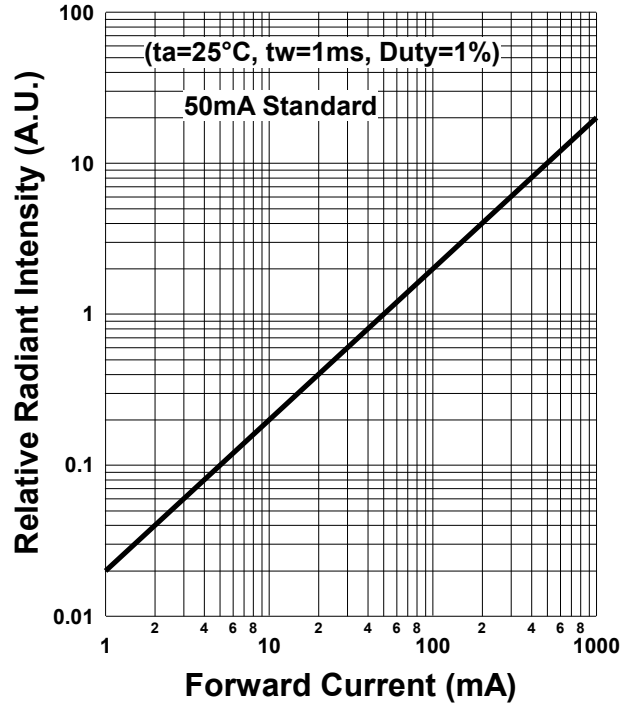

Forward Current - Pulse Duration

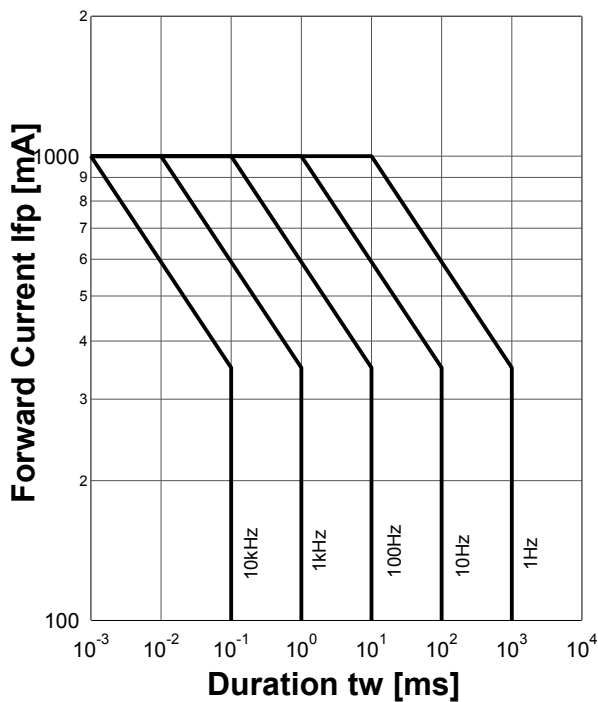

Allowable Forward Current - Ambient Temperature

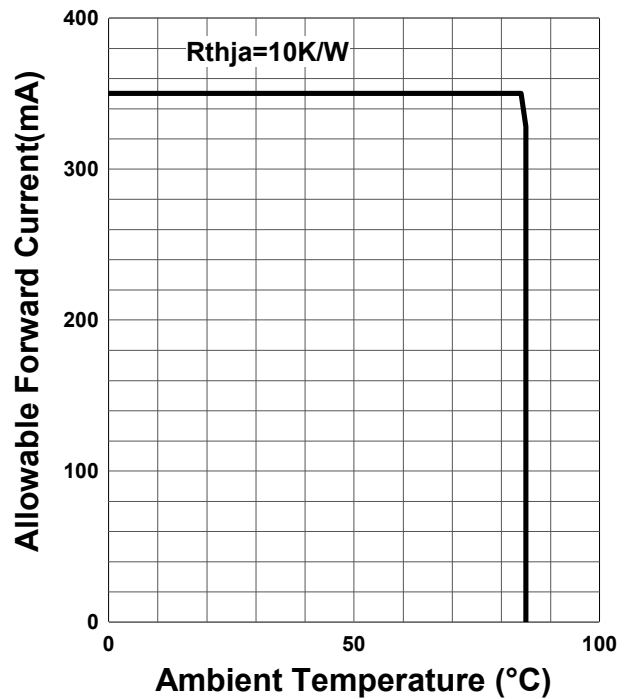

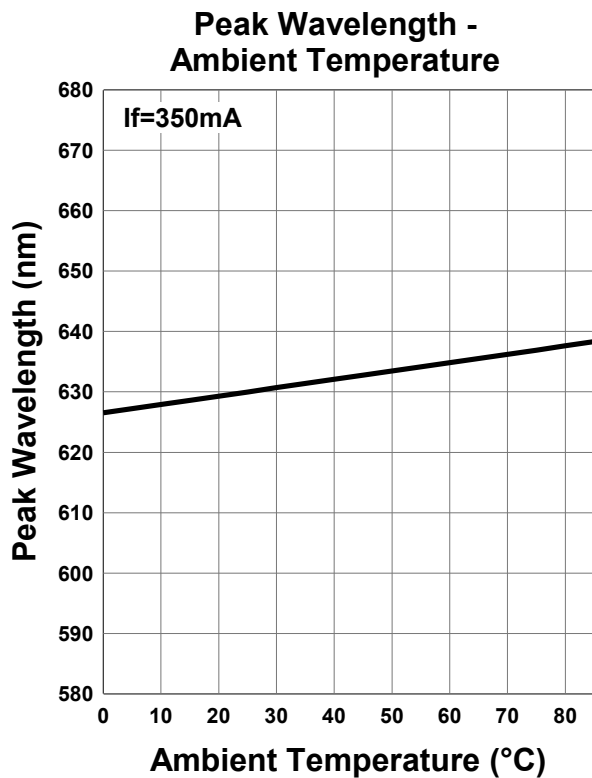
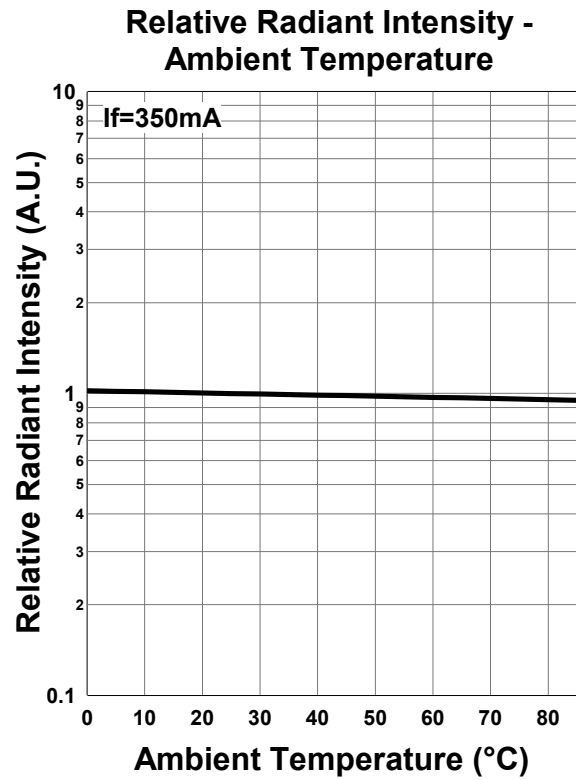
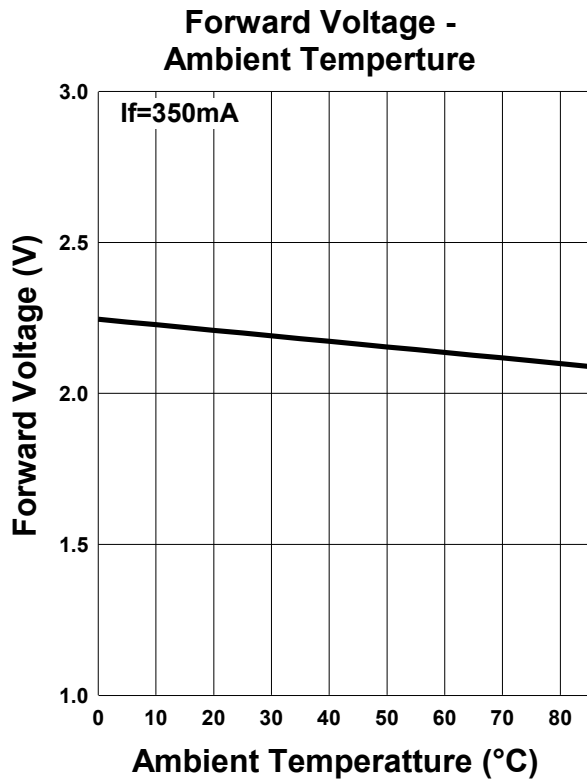

Relative Spectral Emission

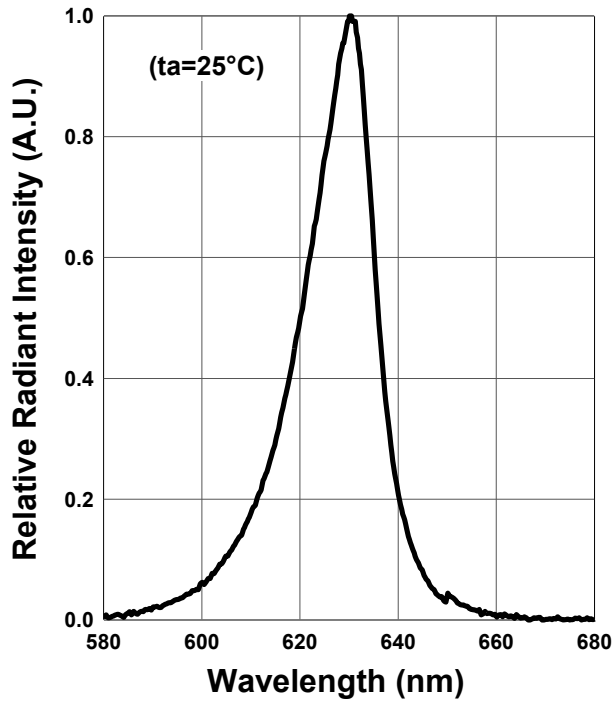

Radiation Characteristics

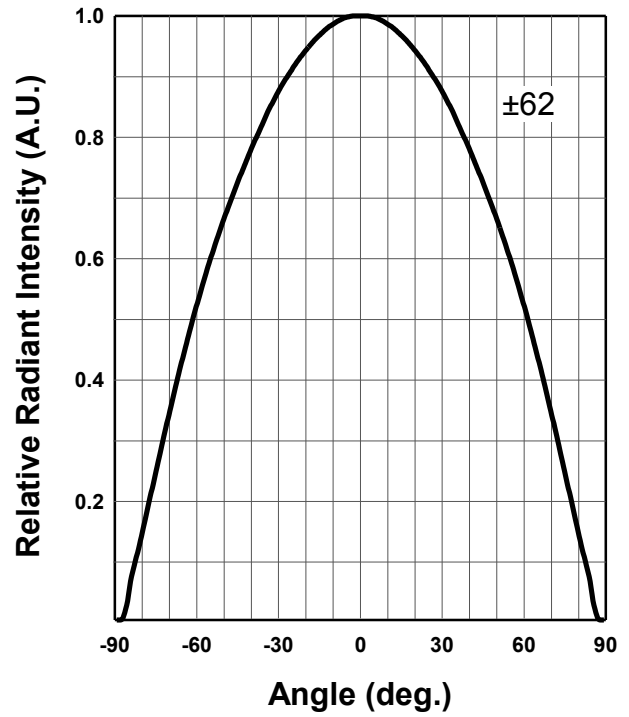

◆ Wrapping

Moisture barrier bag aluminum laminated film with a desiccant to keep out the moisture absorption during the transportation and storage.

SMD LED STORAGE AND HANDLING PRECAUTIONS**<Storage Conditions before Opening a Moisture-Barrier Aluminum Bag>**

- Before opening a moisture-barrier aluminum bag, please store it at <30°C, <60%RH. Please note that the maximum shelf life is 12 months under these conditions.

<Storage Conditions after Opening a Moisture-Barrier Aluminum Bag>

- After opening a moisture-barrier aluminum bag, store the aluminum bag and silica gel in a desiccator.
- After opening the bag, please solder the LEDs within 72 hours in a room with 5 - 30°C, <50%RH.
- Please put any unused, remaining LEDs and silica gel back in the same aluminum bag and then vacuum-seal the bag.
- It is recommended to keep the re-sealed bag in a desiccator at <30%RH.

<Notes about Re-sealing a Moisture-Barrier Aluminum Bag>

- When vacuum-sealing an opened aluminum bag, if you find the moisture-indicator of the silica gel has changed to pink from blue (indicating a relative humidity of 30 % or more), please do not use the unused LEDs, the aluminum bag, or the silica gel.

<Notes about Opening a Re-sealed Moisture-Barrier Aluminum Bag>

- When opening a vacuumed and re-sealed aluminum bag in order to use the remaining LEDs stored in the bag, if you find that the moisture-indicator of the silica has changed to pink, please do not use the LEDs.

※The 72-hour- long floor life does not include the time while LEDs are stored in the moisture-barrier aluminum bag.

However, we strongly recommend to solder the LEDs as soon as possible after opening the aluminum bag.

Disclaimer

Product specifications and data shown in this product catalog are subject to change without notice for the purposes of improving product performance, reliability, design, or otherwise.

Product data and parameters in this catalog are typical values based on reasonably up-to-date measurements. Product data and parameters may vary by user application and over time.

Products shown in this catalog are intended to be used for general electronic equipment. Products are not guaranteed for applications where product malfunction or failure may cause personal injury or death, including but not limited to life-supporting / saving devices, medical devices, safety devices, airplanes, aerospace equipment, automobiles, traffic control systems, and nuclear reactor control systems.