

L780-66-16100
Red Color Illuminator

L780-66-16100 is composed of 1mm x 1mm high current drive AlGaAs die by 16pcs, and mounted on a metal stem TO-66 and covered with epoxy resin or silicone resin. It is designed for extremely high output power illuminator assembled.

<Features>

- High Current Use
- High Reliability
- High Output Power at 780nm

<Specifications>

1. Product Name: Red Color Illuminator
2. Type Number: L780-66-16100
3. Chip:
 - Chip material: AlGaAs
 - Dimension: 1mm x 1mm
 - Peak Wavelength: 780nm
4. Package
 - Type: TO-66 Stem
 - Lens: Silicone and/or Epoxy Lens

Outer Dimension (Unit:mm)

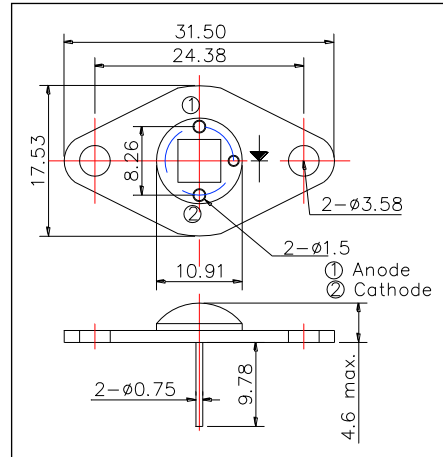

Absolute Maximum Ratings[Ta=25°C]			
Item	Symbol	Maximum Rated Value	Unit
Power Dissipation	PD	26	W
Forward Current	IF	3200	mA
Reverse Voltage	VR	20	V
Operating Temperature	TOPR	-40 ~ +85	°C
Storage Temperature	TSTG	-40 ~ +100	°C
Soldering Temperature*	TSOL	265	°C

* Soldering condition must be completed within 3 second at 265 °C.

Electro-Optical Characteristics						
Item	Symbol	Condition	Minimum	Typical	Maximum	Unit
Forward Voltage	VF	IF=3.2A		8.0		V
Radiated Power*	PO	IF=3.2A		2.8		W
Peak Wavelength	λP	IF=3.2A		780		nm
Half Width	Δλ	IF=3.2A		30		nm
Viewing Half Angle	θ1/2	IF=100mA		± 63		deg

* Measured by S3584-08



Forward Current - Forward Voltage

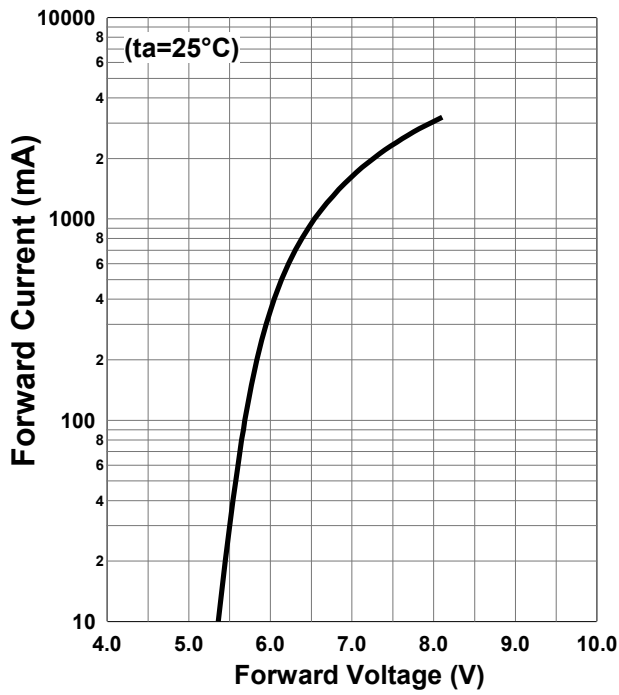

Relative Radiant Intensity - Forward Current

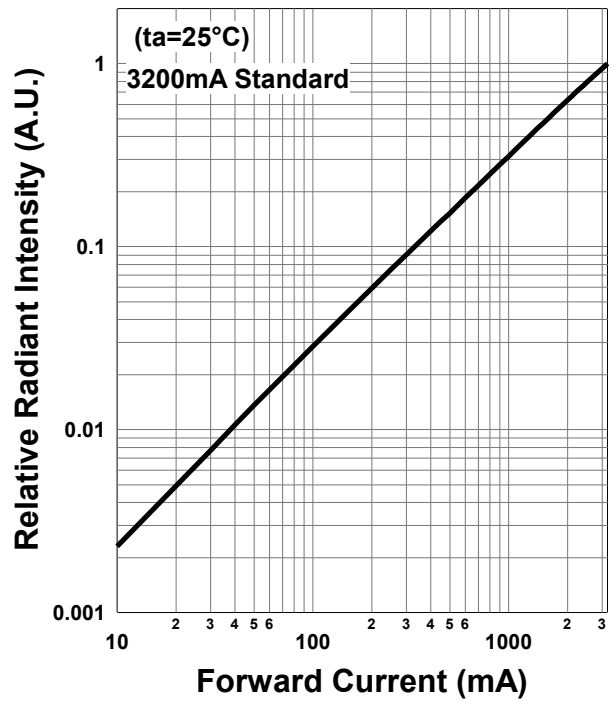

Radiation Characteristics

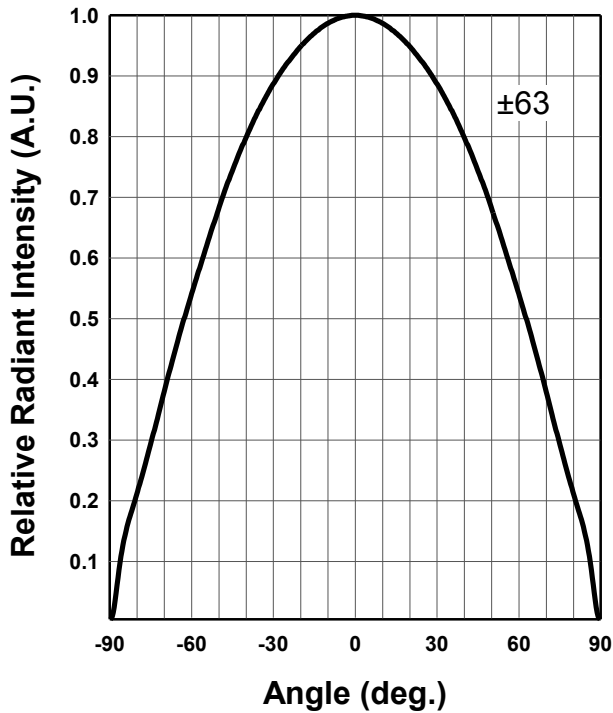

*The data below shows the characteristics of one representative TO-66 chip.

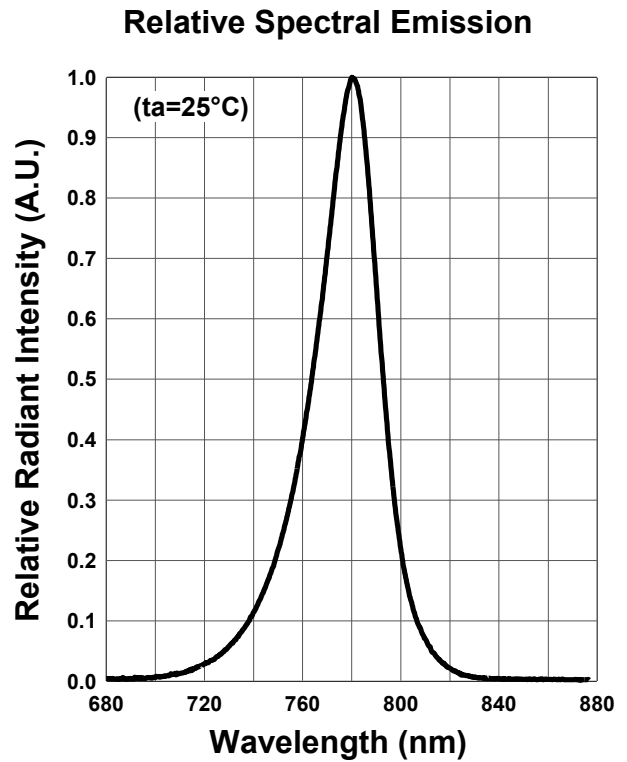
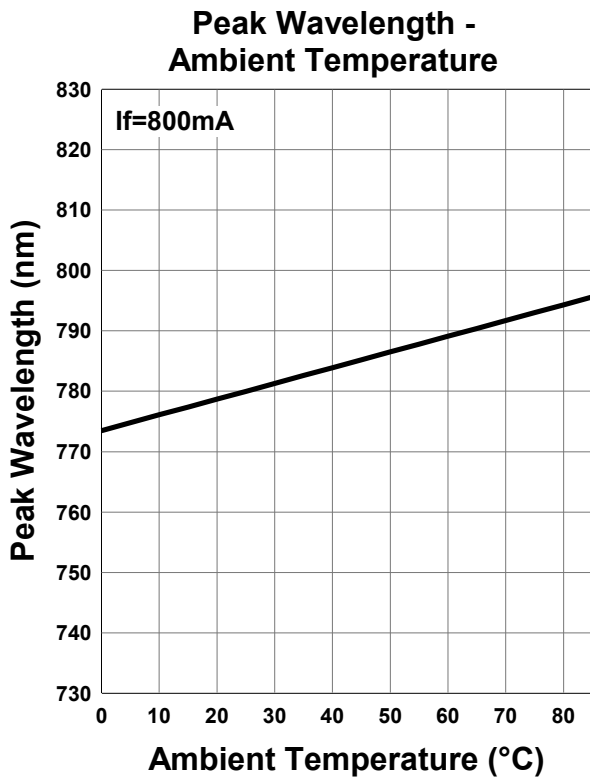
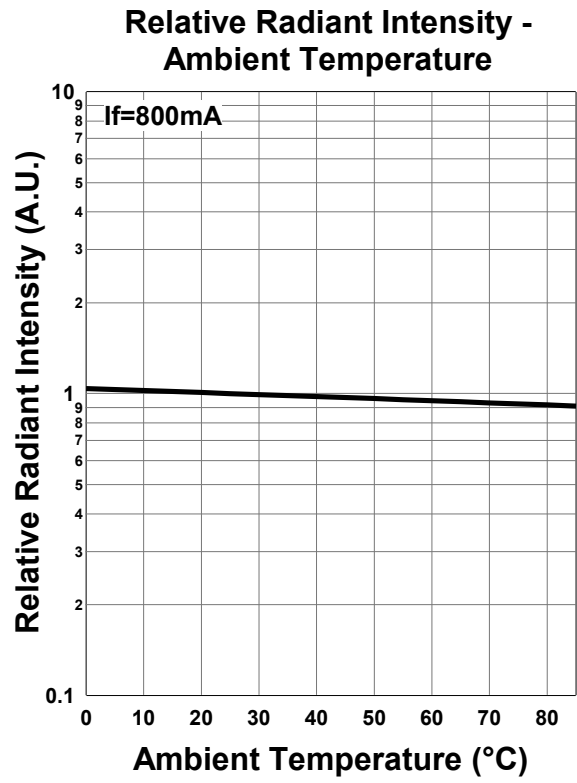
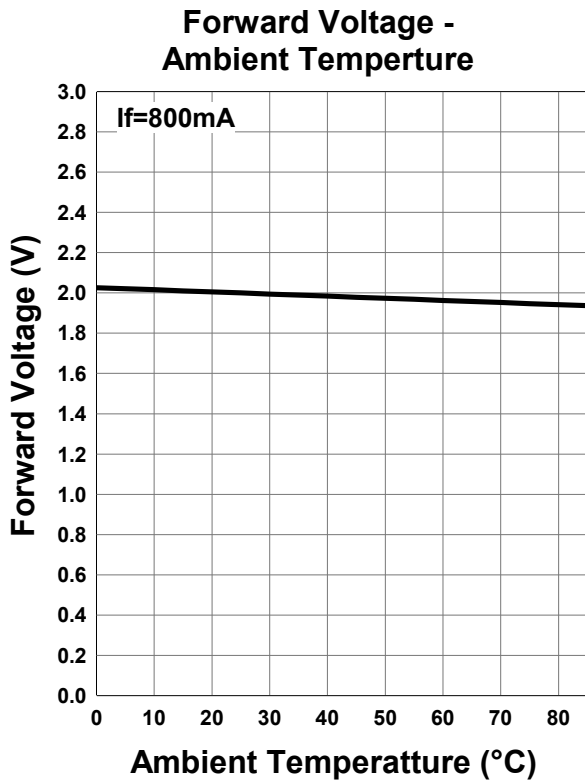

Disclaimer

Product specifications and data shown in this product catalog are subject to change without notice for the purposes of improving product performance, reliability, design, or otherwise.

Product data and parameters in this catalog are typical values based on reasonably up-to-date measurements. Product data and parameters may vary by user application and over time.

Products shown in this catalog are intended to be used for general electronic equipment. Products are not guaranteed for applications where product malfunction or failure may cause personal injury or death, including but not limited to life-supporting / saving devices, medical devices, safety devices, airplanes, aerospace equipment, automobiles, traffic control systems, and nuclear reactor control systems.

2013.05