

L1200-06
Infrared LED Lamp

L1200-06 is an InGaAsP LED mounted on a lead frame with a clear epoxy lens. On forward bias, it emits a spectral band of radiation which peaks at 1200nm.

<Specifications>

1. Product Name: Infrared LED Lamp
2. Type Number: L1200-06
3. Chip:
 - Chip material: InGaAsP
 - Peak Wavelength: 1200nm typ.
4. Package
 - Type: Φ 5mm Clear Molding
 - Resin: Epoxy Resin
 - Lead Frame: Soldered(Lead Free)

Outer Dimension (Unit:mm)

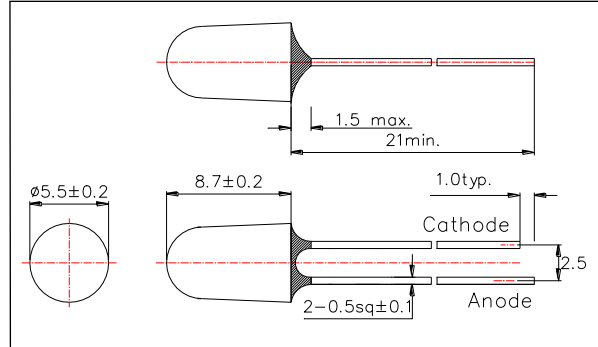

Absolute Maximum Ratings [Ta=25°C]

Item	Symbol	Maximum Rated Value	Unit
Power Dissipation	PD	150	mW
Forward Current	IF	100	mA
Pulse Forward Current*	IFP	1000	mA
Reverse Voltage	VR	5	V
Junction Temperature	Tj	120	°C
Thermal Resistance	Rthjp	250	K/W
Operating Temperature	TOPR	-40 ~ +100	°C
Storage Temperature	TSTG	-40 ~ +100	°C
Soldering Temperature**	TSOL	250	°C

* Duty=1% and Pulse Width=10 μ s

** Soldering condition must be completed within 5 second at 250 °C.

Electro-Optical Characteristics [Ta=25°C]

Item	Symbol	Condition	Minimum	Typical	Maximum	Unit
Forward Voltage	VF	IF=50mA		1.2	1.5	V
	VFP	IF=1A		1.8		
Radiated Power*	PO	IF=50mA		6.0		mW
		IF=1A		50		
Radiant Intensity**	IE	IF=50mA		92		mW/sr
		IF=1A		740		
Peak Wavelength	λ P	IF=50mA	1150	1200	1250	nm
Half Width	$\Delta\lambda$	IF=50mA		85		nm
Viewing Half Angle	θ 1/2	IF=50mA		\pm 8		deg

* Measured by G8370-85

** Measured by ANDO Optical Multi Meter AQ2140&AQ2743



Forward Current - Forward Voltage

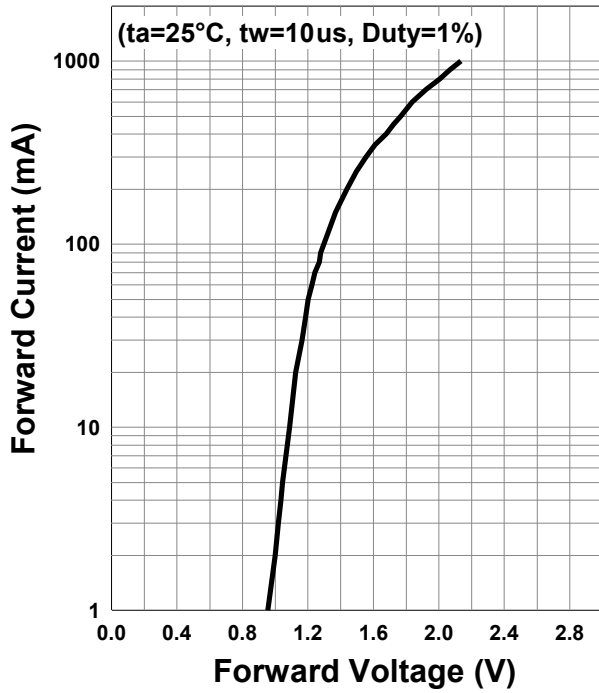

Relative Radiant Intensity - Forward Current

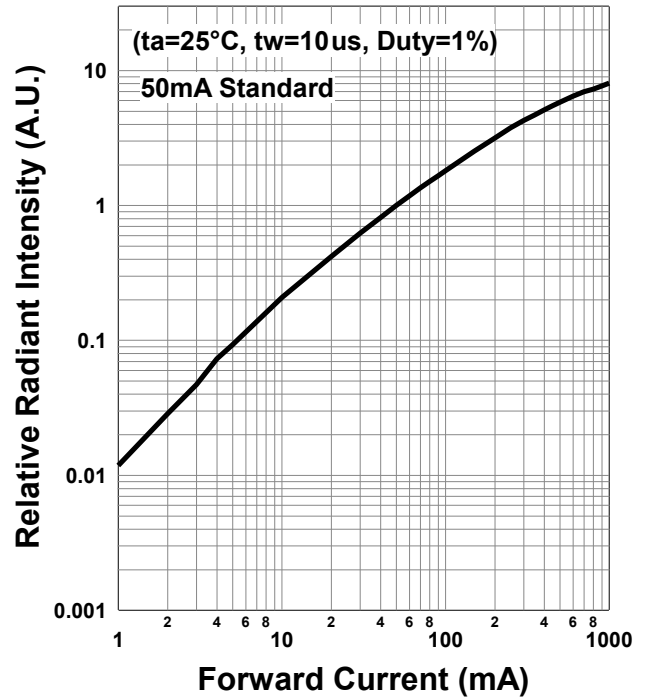

Forward Current - Pulse Duration

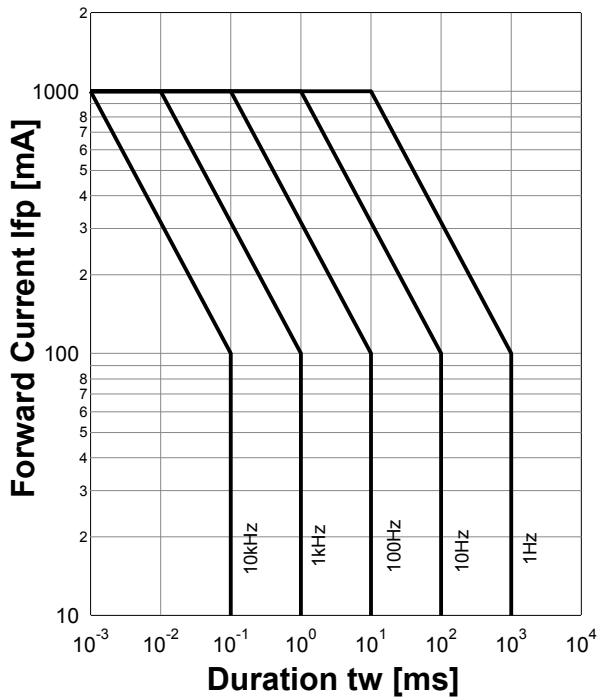

Allowable Forward Current - Ambient Temperature

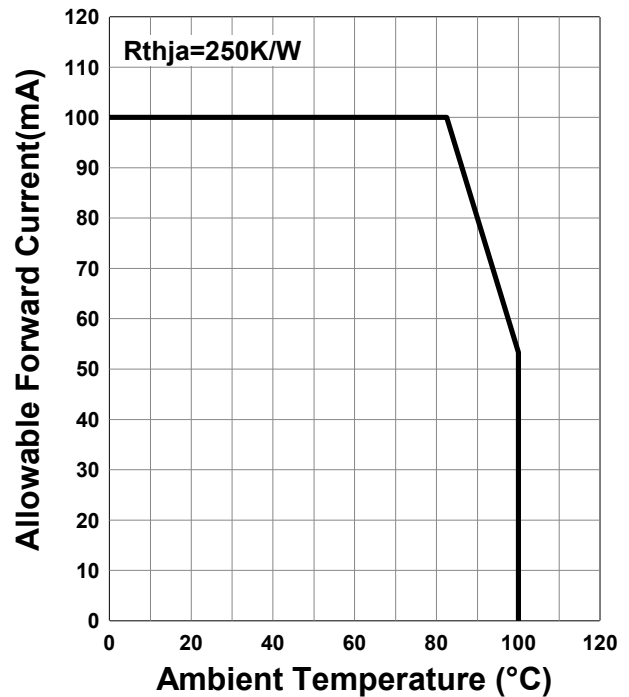

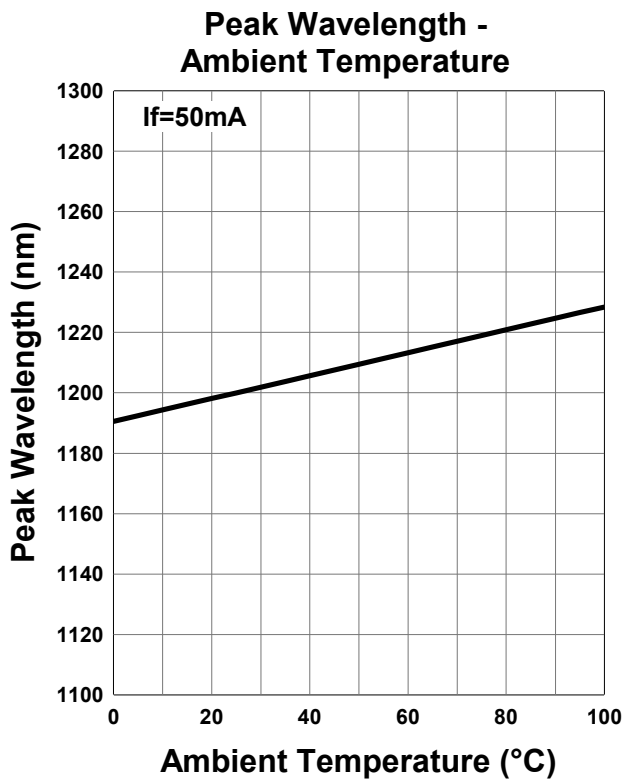
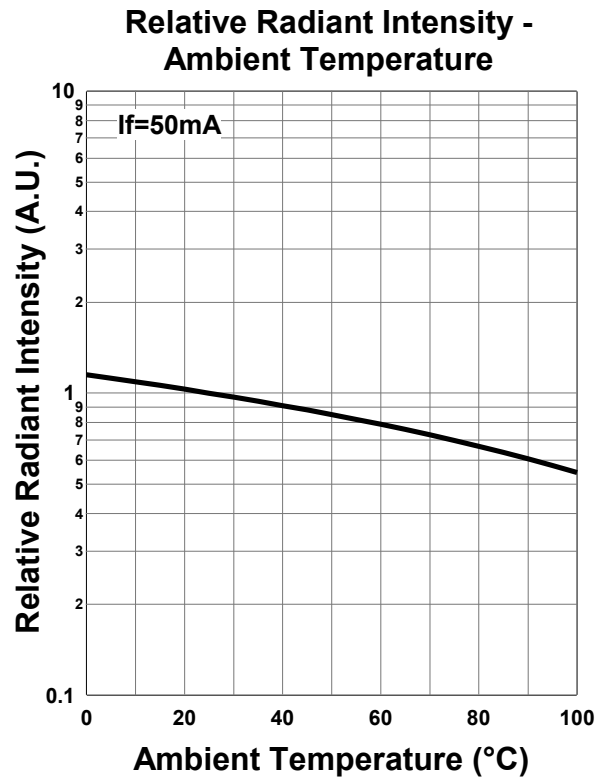
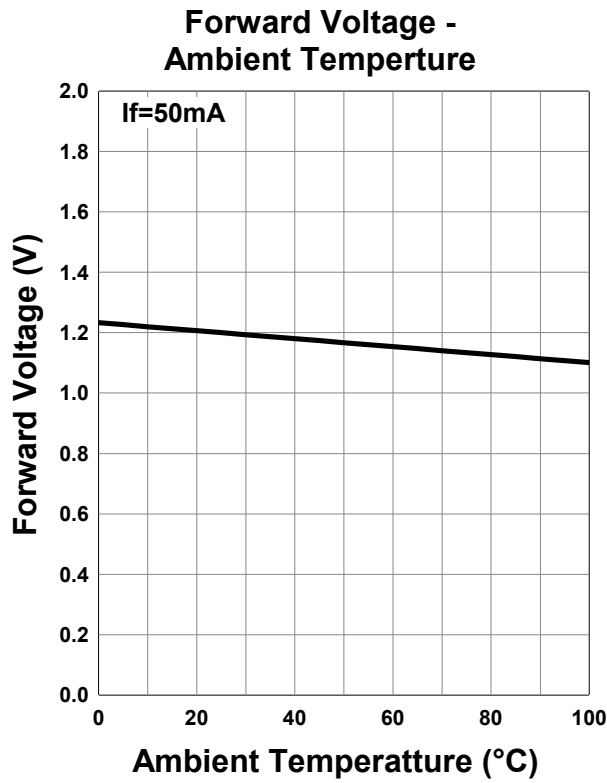

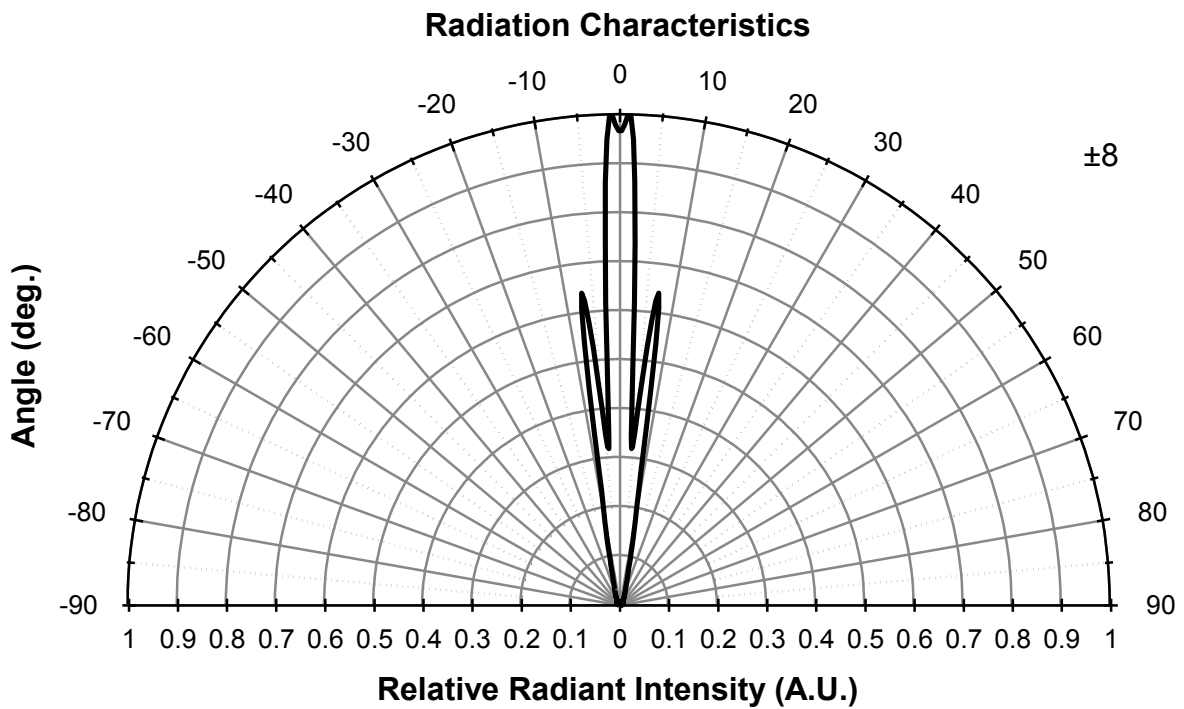
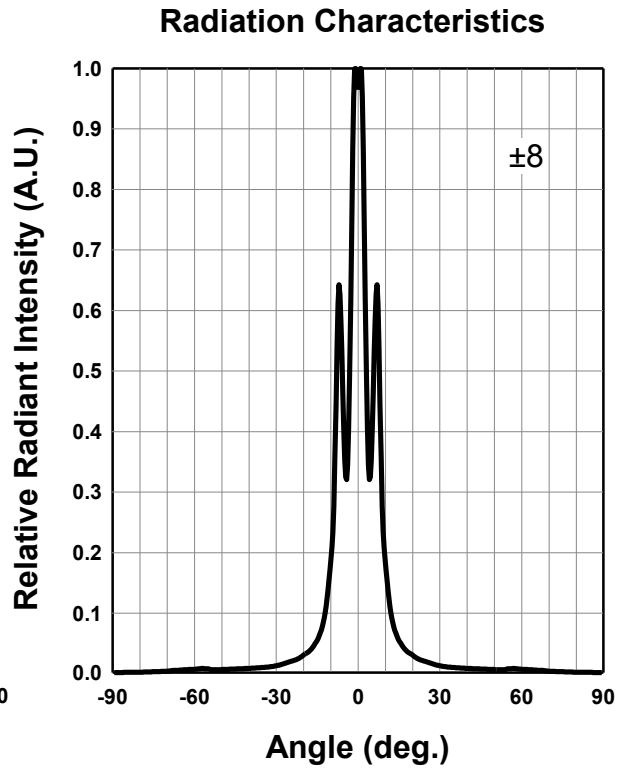
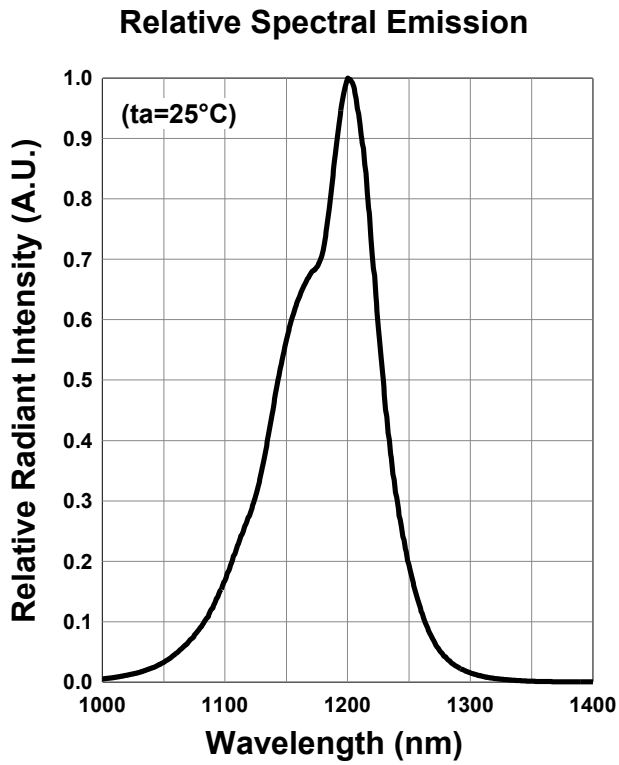

Disclaimer

Product specifications and data shown in this product catalog are subject to change without notice for the purposes of improving product performance, reliability, design, or otherwise.

Product data and parameters in this catalog are typical values based on reasonably up-to-date measurements. Product data and parameters may vary by user application and over time.

Products shown in this catalog are intended to be used for general electronic equipment. Products are not guaranteed for applications where product malfunction or failure may cause personal injury or death, including but not limited to life-supporting / saving devices, medical devices, safety devices, airplanes, aerospace equipment, automobiles, traffic control systems, and nuclear reactor control systems.

2014.05