

SMT570 High Performance Yellow Green color TOP LED

SMT570 consists of an AlGaInP LED mounted on the lead frame as TOP LED package and is 60mcd typical of Brightness. It emits a spectral band of radiation at 570nm.

◆ Specifications

1) Product Name	TOP LED
2) Type No.	SMT570
3) Chip	
(1) Chip Material	AlGaInP
(2) Peak Wavelength	570nm typ.
4) Package	
(1) Lead Frame Die	Silver Plated
(2) Package Resin	PPA Resin
(3) Lens	Epoxy Resin

◆ Outer dimension (Unit: mm)

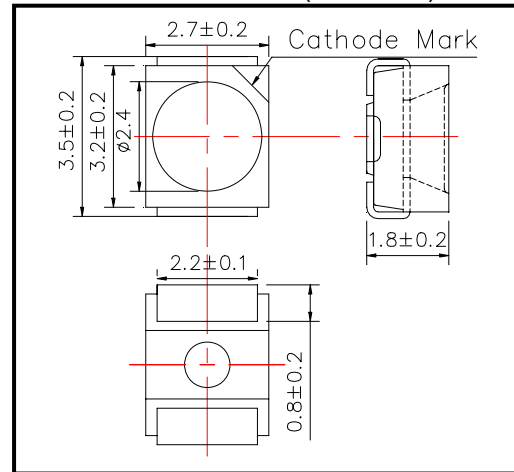

◆ Absolute Maximum Ratings

Item	Symbol	Maximum Rated Value	Unit	Ambient Temperature
Power Dissipation	P _D	60	mW	T _a =25°C
Forward Current	I _F	30	mA	T _a =25°C
Reverse Voltage	V _R	5	V	T _a =25°C
Operating Temperature	T _{OPR}	-20 ~ +80	°C	
Storage Temperature	T _{STG}	-30 ~ +80	°C	
Soldering Temperature	T _{SOL}	240	°C	

‡Soldering condition: Soldering condition must be completed within 3 seconds at 230°C

◆ Electro-Optical Characteristics [T_a=25°C]

Item	Symbol	Condition	Minimum	Typical	Maximum	Unit
Forward Voltage	V _F	I _F =20mA		1.95	2.20	V
Reverse Current	I _R	V _R =5V			10	uA
Total Radiated Power	P _O	I _F =20mA		0.3		mW
Brightness	I _v	I _F =20mA		60		mcd
Peak Wavelength	λ _P	I _F =20mA	560	570	580	nm
Half Width	Δλ	I _F =20mA		15		nm
Viewing Half Angle	θ _{1/2}	I _F =20mA		±55		deg.

‡Total Radiated Power is measured by Photodyne #500

‡Brightness is measured by Tektronix J-16.