

SMB780-1100-09-I

High Power type Top LED with Lens

SMB780-1100-09-I is an AlGaAs LED mounted on copper heat sink with a 5*5 mm package. These devices are available to be operated and 1050mW/sr at IFP=4A.

◆ Specifications

- 1) Product Name High Power Top LED
- 2) Type No. SMB780-1100-09-I
- 3) Chip
 - (1) Chip Material AlGaAs
 - (2) Chip Dimension 1000um*1000um
 - (3) Chip Number 1pce
 - (4) Peak Wavelength 780nm typ.
- 4) Package
 - (1) Lead Frame Die Silver Plated on Copper
 - (2) Insulator AlN ceramics
 - (3) Package Resin PPA Resin
 - (4) Lens Epoxy Resin

◆ Outer dimension (Unit: mm)

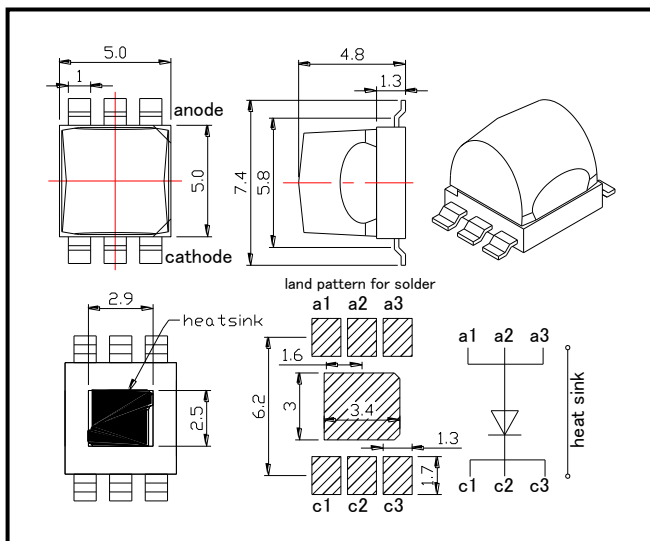

◆ Absolute Maximum Ratings

| Item | Symbol | Maximum Rated Value | Unit | Ambient Temperature |
|-----------------------|-------------------|---------------------|------|----------------------|
| Power Dissipation | P _D | 2500 | mW | T _a =25°C |
| Forward Current | I _F | 800 | mA | T _a =25°C |
| Pulse Forward Current | I _{FP} | 4000 | mA | T _a =25°C |
| Reverse Voltage | V _R | 5 | V | T _a =25°C |
| Thermal Resistance | R _{thja} | 10 | K/W | |
| Junction Temperature | T _j | 100 | °C | |
| Operating Temperature | T _{OPR} | -30 ~ +85 | °C | |
| Storage Temperature | T _{STG} | -30 ~ +100 | °C | |
| Soldering Temperature | T _{SOL} | 255 | °C | |

‡Pulse Forward Current condition: Duty=1% and Pulse Width=10us.

‡Soldering condition: Soldering condition must be completed within 5 seconds at 255°C

◆ Electro-Optical Characteristics [T_a=25°C]

| Item | Symbol | Condition | Minimum | Typical | Maximum | Unit |
|--------------------|------------------|-----------------------|---------|---------|---------|-------|
| Forward Voltage | V _F | I _F =800mA | | 2.0 | 2.5 | V |
| | V _{FP} | I _{FP} =4A | | 4.5 | 5.5 | V |
| Radiated Power | P _O | I _F =800mA | | 330 | | mW |
| | | I _{FP} =4A | | 1650 | | |
| Radiant Intensity | I _E | I _F =800mA | | 210 | | mW/sr |
| | | I _{FP} =4A | | 1050 | | |
| Peak Wavelength | λ _P | I _F =100mA | | 780 | | nm |
| Half Width | Δλ | I _F =100mA | | 25 | | nm |
| Viewing Half Angle | θ _{1/2} | I _F =100mA | | long | ±44 | deg. |
| | | | | short | ±21 | |
| Rise Time | t _r | I _F =100mA | | 80 | | ns |
| Fall Time | t _f | I _F =100mA | | 80 | | ns |

‡Radiated Power is measured by S3584-08.

‡Radiant Intensity is measured by Tektronix J-6512.

Forward Current - Forward Voltage

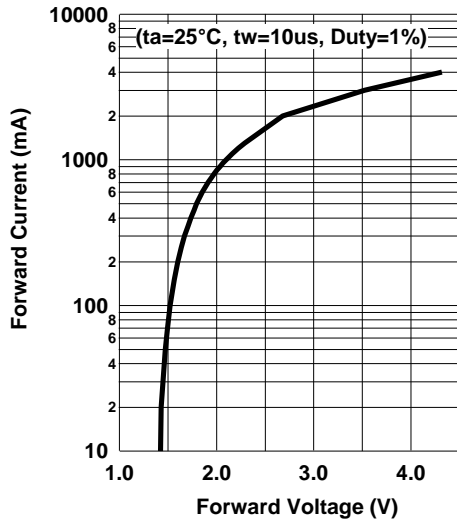

Relative Radiant Intensity - Forward Current

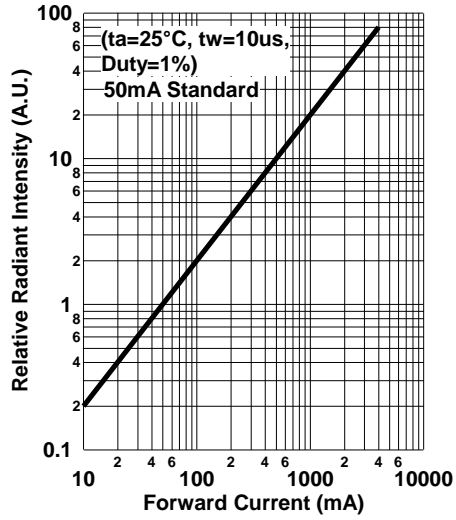

Forward Current-Pulse Duration

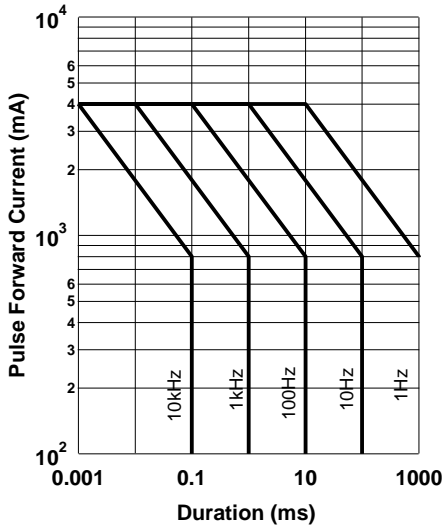

Allowable Forward Current - Ambient Temperature

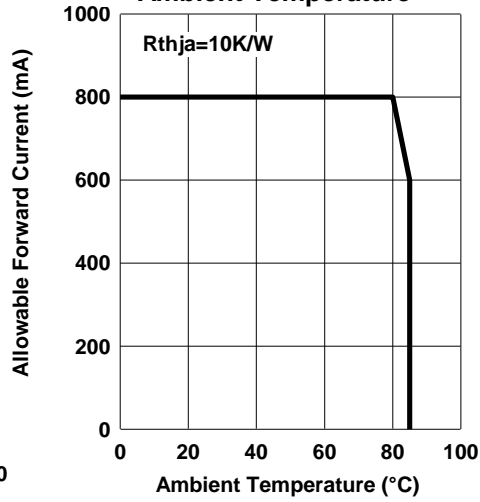

Relative Spectral Emission

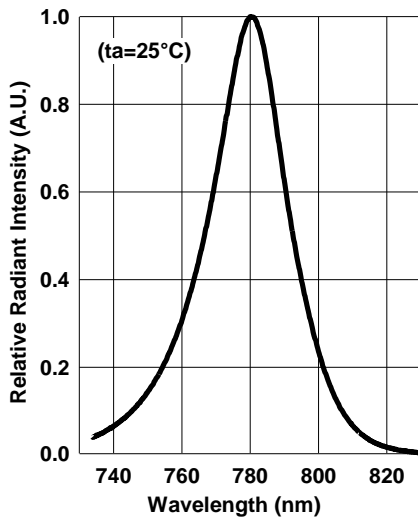

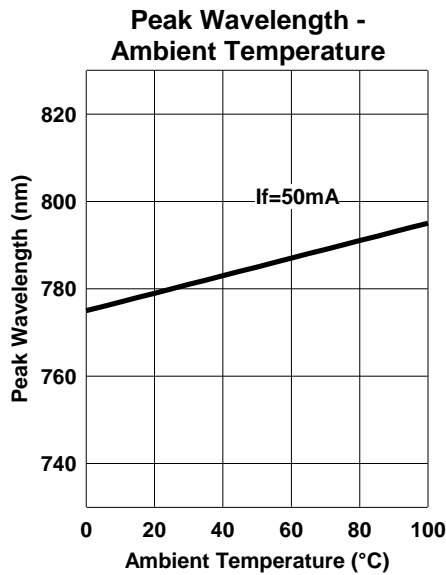
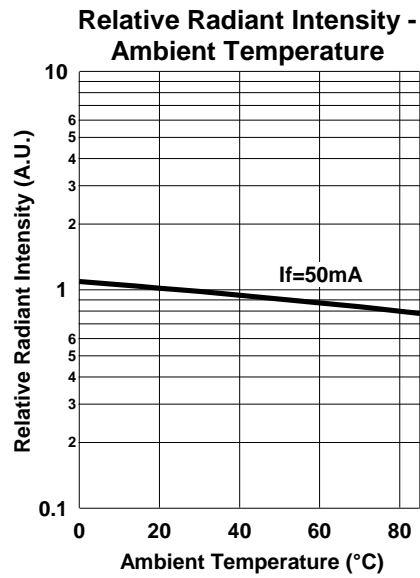
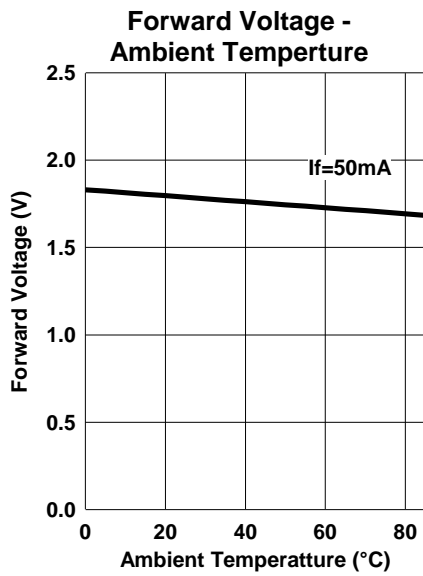

◆ Wrapping

Moisture barrier bag aluminum laminated film with a desiccant to keep out the moisture absorption during the transportation and storage.

Radiation Pattern

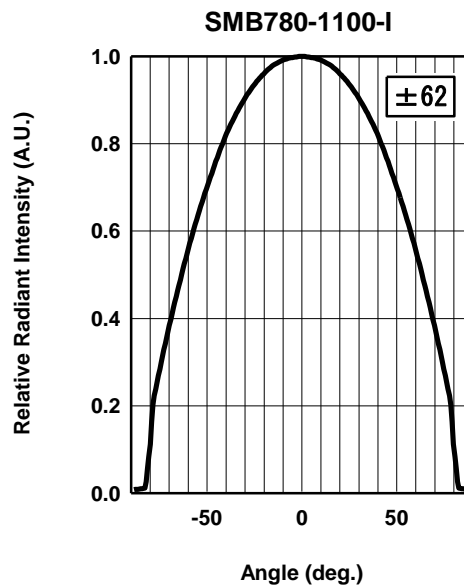
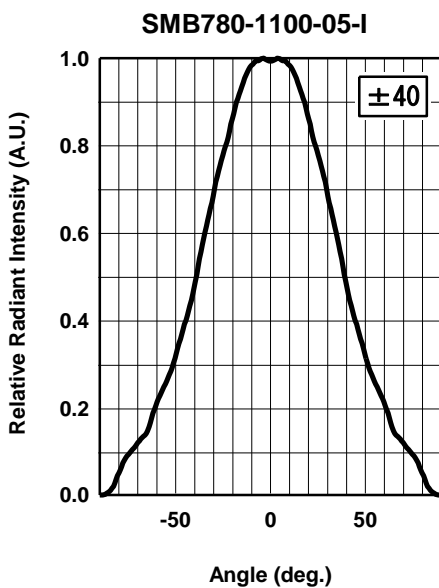
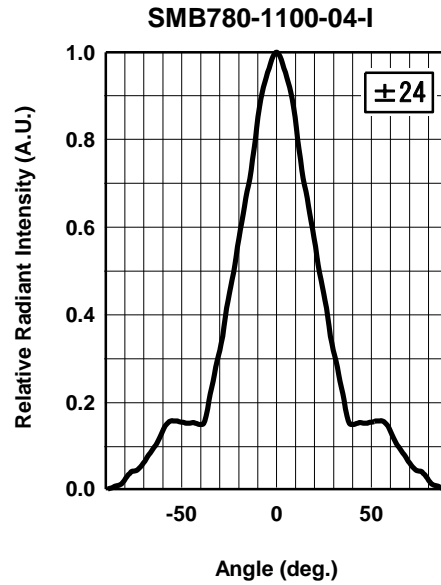
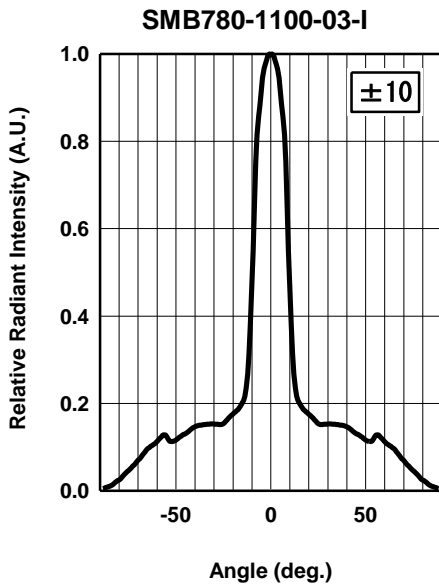
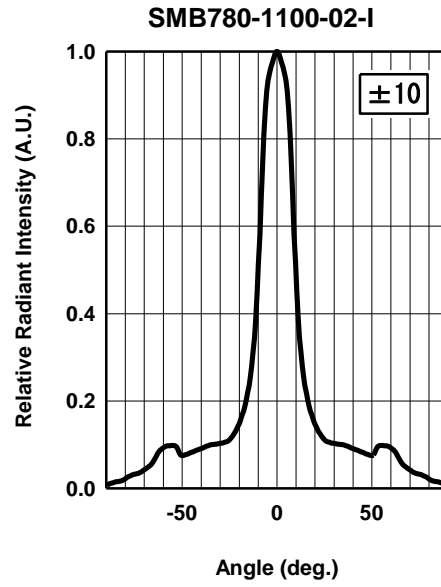
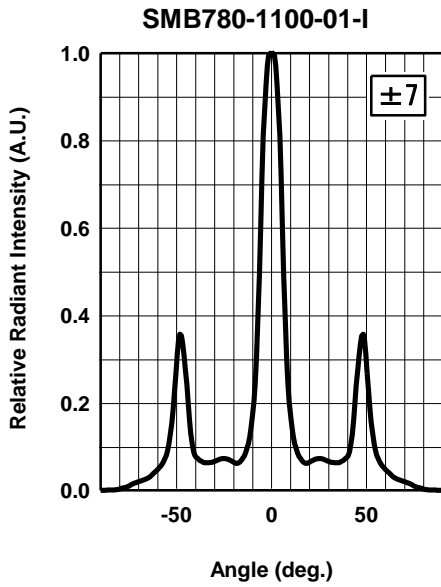

Radiation Pattern

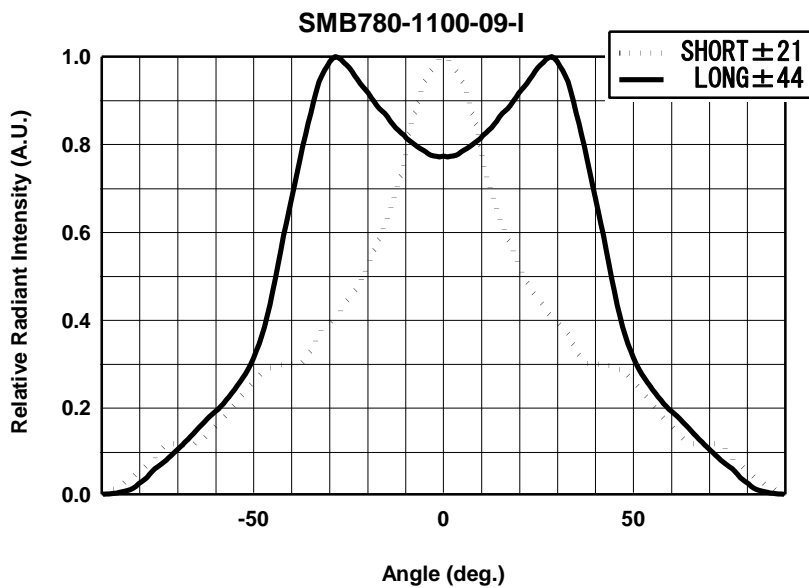

SMD LED STORAGE AND HANDLING PRECAUTIONS

< Storage Conditions before Opening a Moisture-Barrier Aluminum Bag >

- Before opening a moisture-barrier aluminum bag, please store it at <30°C, <60%RH. Please note that the maximum shelf life is 12 months under these conditions.

< Storage Conditions after Opening a Moisture-Barrier Aluminum Bag >

- After opening a moisture-barrier aluminum bag, store the aluminum bag and silica gel in a desiccator.
- After opening the bag, please solder the LEDs within 48 hours in a room with 5 - 30°C, <50%RH.
- Please put any unused, remaining LEDs and silica gel back in the same aluminum bag and then vacuum-seal the bag.
- It is recommended to keep the re-sealed bag in a desiccator at <30%RH.

< Notes about Re-sealing a Moisture-Barrier Aluminum Bag >

- When vacuum-sealing an opened aluminum bag, if you find the moisture-indicator of the silica gel has changed to pink from blue (indicating a relative humidity of 30 % or more), please do not use the unused LEDs, the aluminum bag, or the silica gel.

< Notes about Opening a Re-sealed Moisture-Barrier Aluminum Bag >

- When opening a vacuumed and re-sealed aluminum bag in order to use the remaining LEDs stored in the bag, if you find that the moisture-indicator of the silica has changed to pink, please do not use the LEDs.

※The 48-hour- long floor life does not include the time while LEDs are stored in the moisture-barrier aluminum bag.

However, we strongly recommend to solder the LEDs as soon as possible after opening the aluminum bag.