

PD1450-35T52 InGaAs PIN-PD

PD1450-35T52 is InGaAs PIN-photodiode.

This PIN-photodiode consists of a large chip with 0.35x0.35mm active area mounted on the TO-18 stem and is hermetically sealed by metal can with flat lens.

These devices are designed to be easy of setting up optically with a wide angle of half sensitivity of $\pm 40^\circ$.

◆ Features

- 1) High Reliability
- 2) High Response

◆ Specifications

- 1) Product Name InGaAs PIN Photo-Diode
- 2) Type No. PD1450-35T52
- 3) Chip
 - (1) Active Area 0.35mmx0.35mm
- 4) Package
 - (1) Type TO-18
 - (2) Lens Glass Flat Lens ($\Phi 2.4$)
 - (2) Cap Gold Plated

◆ Outer dimension (Unit:mm)

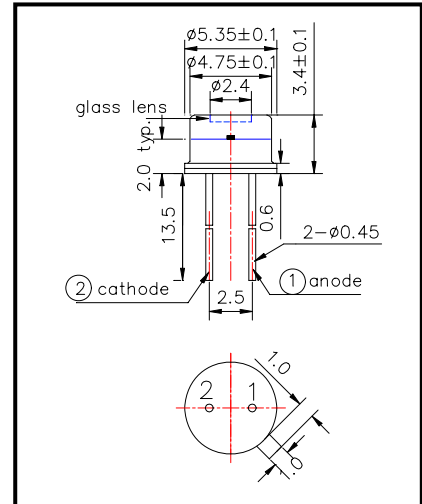

◆ Absolute Maximum Ratings

Item	Symbol	Maximum Rated Value	Unit
Reverse Breakdown Voltage	$V_{(BR)R}$	10	V
Operating Temperature	T_{OPR}	-20 ~ +90	$^\circ\text{C}$
Storage Temperature	T_{STG}	-30 ~ +100	$^\circ\text{C}$
Soldering Temperature	T_{SOL}	260	$^\circ\text{C}$

‡Pulse Soldering condition: Soldering condition must be completed within 2 seconds at 240°C

◆ Electro-Optical Characteristics [25°C]

Item	Symbol	Condition	Minimum	Typical	Maximum	unit
Photo Responsivity	R_E	$V_R=0V, \lambda_P=1450\text{nm}$		0.9		A/W
Photo Current	I_L	$V_R=0V, \lambda_P=1450\text{nm}$	10	14		$\mu\text{A}(\pm 1)$
Dark Current	I_D	$V_R=1V$			100	nA
Spectral Responsivity (Peak)	λ_P	$V_R=0V$	1000		1600	nm
Half Angle of Sensitivity	$\theta_{1/2}$	$V_R=0V$		± 40		deg.
Total Capacitance	C_T	$f=1\text{MHz}, V_R=1V$		20		pF
Rise/Fall Time(10%~90%)	t_r	$R_L=1\text{K}\Omega, V_R=1V$		10		ns
	t_f			5		ns

‡Measured by Epitex's calibrated tool