

L970-__ __

Infrared LED Lamp

This series of L970-__ __ is a GaAs LED mounted on a lead frame and encapsulated in various types of epoxy lens which offer different design settings.

On forward bias, it emits a high power radiation of typical 5.5mW with a peak wavelength at 970nm.

Specifications

- | | |
|--------------------|-------------|
| 1. Chip material | GaAs |
| 2. Peak wavelength | 970nm |
| 3. Resin Material | Epoxy resin |
| 4. Solder | Lead free |



Absolute Maximum Ratings

Item	Symbol	Maximum Rated Value	Unit	Ambient Temperature
Power Dissipation	P_D	140	mW	$T_a=25^{\circ}\text{C}$
Forward Current	I_F	100	mA	$T_a=25^{\circ}\text{C}$
Pulse Forward Current	I_{FP}	1000	mA	$T_a=25^{\circ}\text{C}$
Reverse Voltage	V_R	5	V	$T_a=25^{\circ}\text{C}$
Operating Temperature	T_{OPR}	-30 ~ +85	$^{\circ}\text{C}$	$T_a=25^{\circ}\text{C}$
Storage Temperature	T_{STG}	-40 ~ +100	$^{\circ}\text{C}$	
Soldering Temperature	T_{SOL}	265	$^{\circ}\text{C}$	

Electro-Optical Characteristics ($T_a=25^{\circ}\text{C}$)

Item	Symbol	Condition	Minimum	Typical	Maximum	Unit
Forward Voltage	V_F	$I_F=50\text{mA}$		1.3	1.5	V
Reverse Current	I_R	$V_R=5\text{V}$			10	μA
Total Radiated Power	P_O	$I_F=50\text{mA}$	3.5	5.5		mW
Peak Wavelength	λ_P	$I_F=50\text{mA}$		970		nm
Half Width	$\Delta\lambda$	$I_F=50\text{mA}$		55		nm
Rise Time	t_r	$I_F=50\text{mA}$		1500		ns
Fall Time	t_f	$I_F=50\text{mA}$		700		ns

Characteristics of Radiant Intensity (Ta=25°C)

Type	Viewing Half Angle	Radiant Intensity I _F =50mA Unit : mW/sr			Outer Dimension	Dimension Figure
		Minimum	Typical	Maximum		
L970-01	±10°		25		Φ5	1
L970-02	±7°		25		Φ5	2
L970-03	±10°		20		Φ5	3
L970-04	±20°		10		Φ5	4
L970-05	±40°		3		Φ5	5
L970-06	±7°		25		Φ5	6
L970-09	±25°(Long) ±15°(Short)		15		Φ5 Oval	7
L970-46					Φ5	8
L970-41	±16°				Φ4	9
L970-42	±23°				Φ4	10
L970-31					Φ3	11
L970-33	±18°		7		Φ3	12
L970-34					Φ3	13
L970-36	±33°		4		Φ3	14

Brightness is measured by Tektronix J-16

Total Radiant Power is measured by Photodyne #500

Outer Dimension of LED Lamp

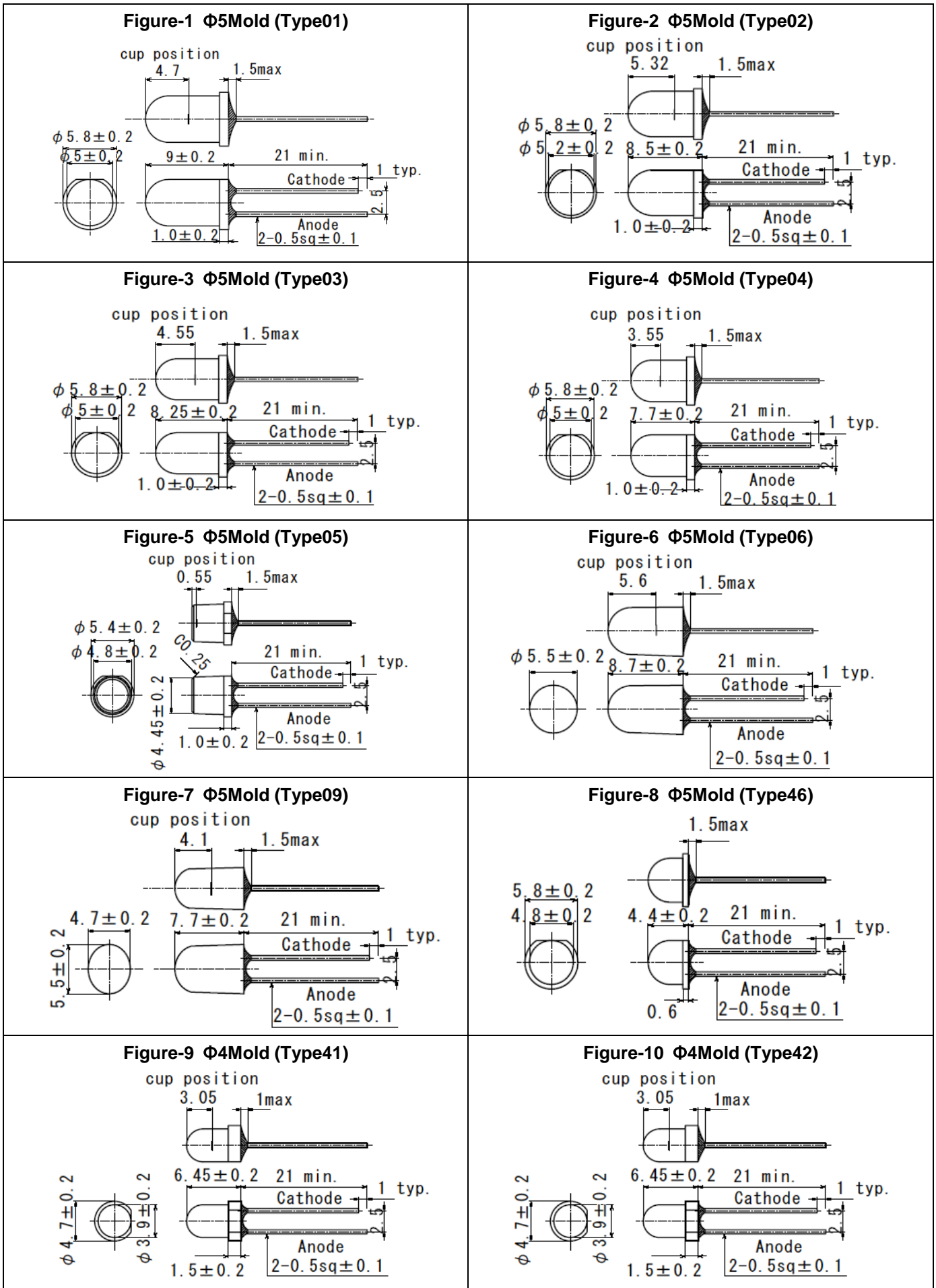

Outer Dimension of LED Lamp

<p>Figure-11 $\Phi 3$Mold (Type31) cup position</p> <p>0.37 1max $\phi 3.6 \pm 0.2$ $\phi 3 \pm 0.2$ 3.5 ± 0.2 21 min. 1 typ. Cathode Anode $2-0.5sq \pm 0.1$ 1.5 typ.</p>	<p>Figure-12 $\Phi 3$Mold (Type33) cup position</p> <p>2.65 1max $\phi 3.8 \pm 0.2$ $\phi 3 \pm 0.2$ 5.3 21 min. 1 typ. Cathode Anode $2-0.5sq \pm 0.1$ 0.8 typ.</p>
<p>Figure-13 $\Phi 3$Mold (Type34) cup position</p> <p>3.25 1max $\phi 3.8 \pm 0.2$ $\phi 3 \pm 0.2$ 5.3 ± 0.2 21 min. 1 typ. Cathode Anode $2-0.5sq \pm 0.1$ 1.5 typ.</p>	<p>Figure-14 $\Phi 3$Mold (Type36) cup position</p> <p>2.1 1max $\phi 4 \pm 0.2$ $\phi 3 \pm 0.2$ 5.3 ± 0.2 21 min. 1 typ. Cathode Anode $2-0.5sq \pm 0.1$ 2 ± 0.4</p>
<p>Figure-15</p>	<p>Figure-16</p>
<p>Figure-17</p>	<p>Figure-18</p>
<p>Figure-19</p>	<p>Figure-20</p>

The Viewing half angle

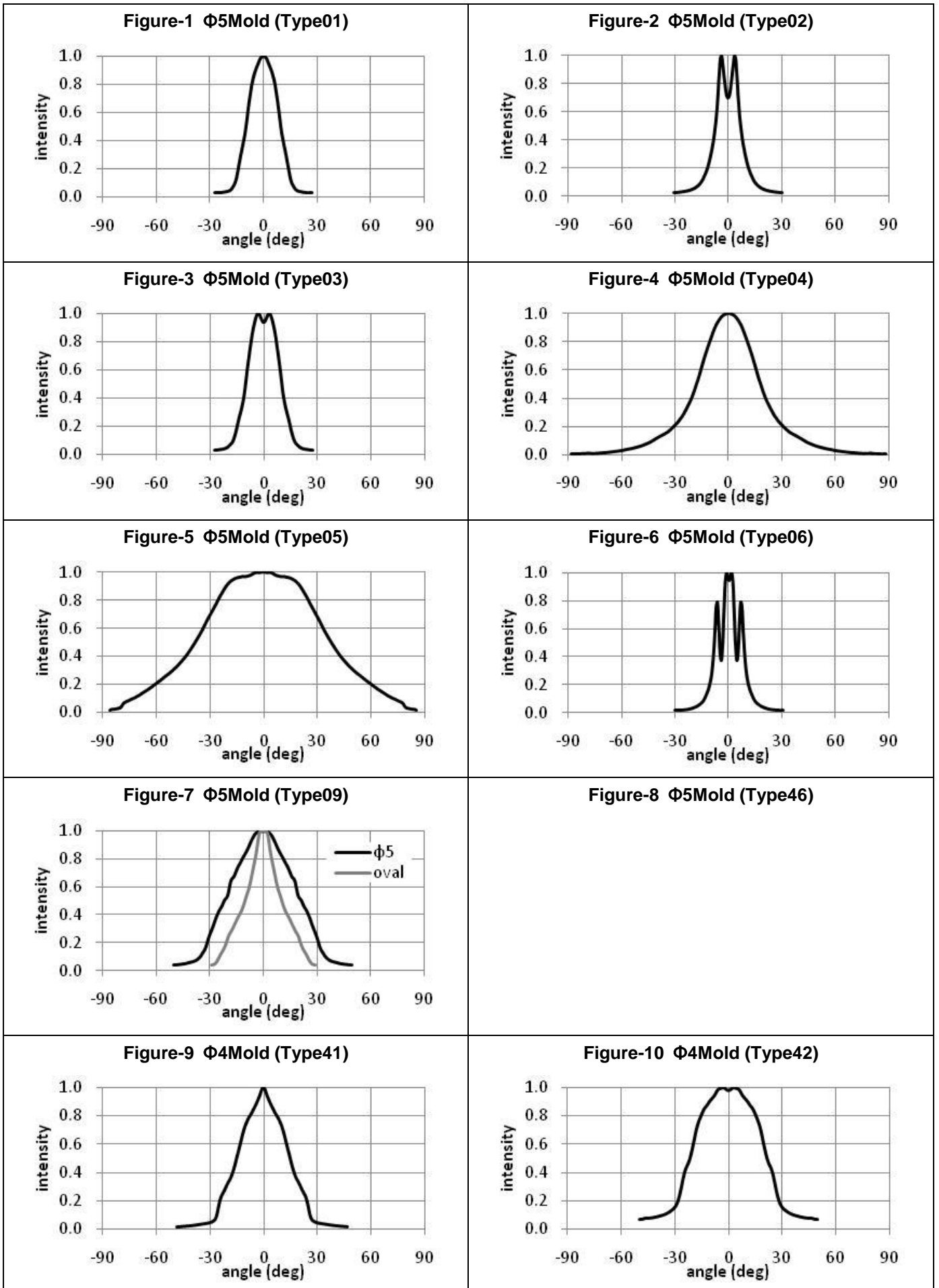

The Viewing half angle

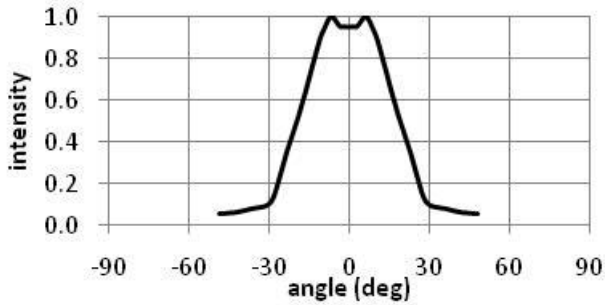
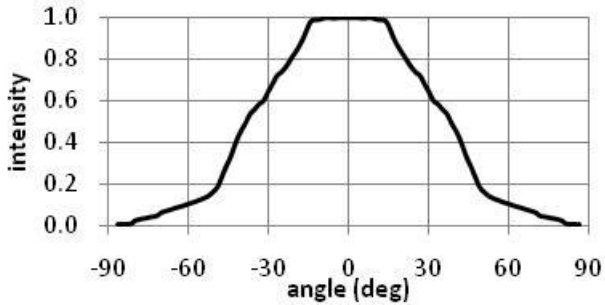
<p>Figure-11 Φ3Mold (Type31)</p>	<p>Figure-12 Φ3Mold (Type33)</p> 
<p>Figure-13 Φ3Mold (Type34)</p>	<p>Figure-14 Φ3Mold (Type36)</p> 
<p>Figure-15</p>	<p>Figure-16</p>
<p>Figure-17</p>	<p>Figure-18</p>
<p>Figure-19</p>	<p>Figure-20</p>

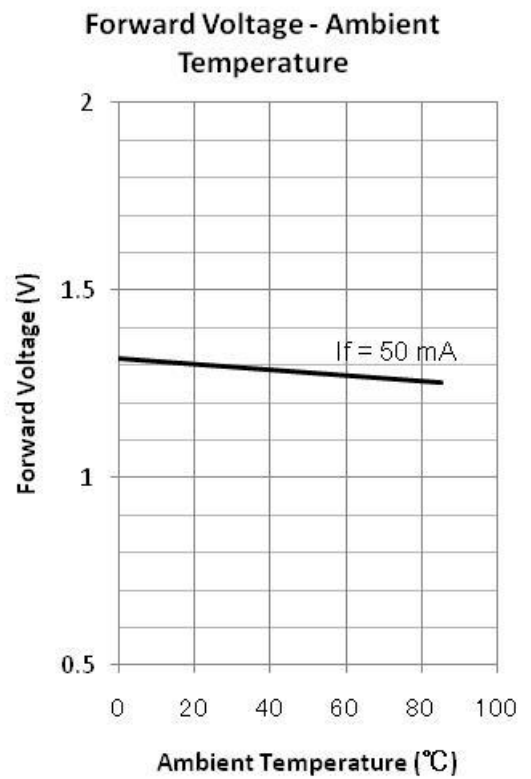
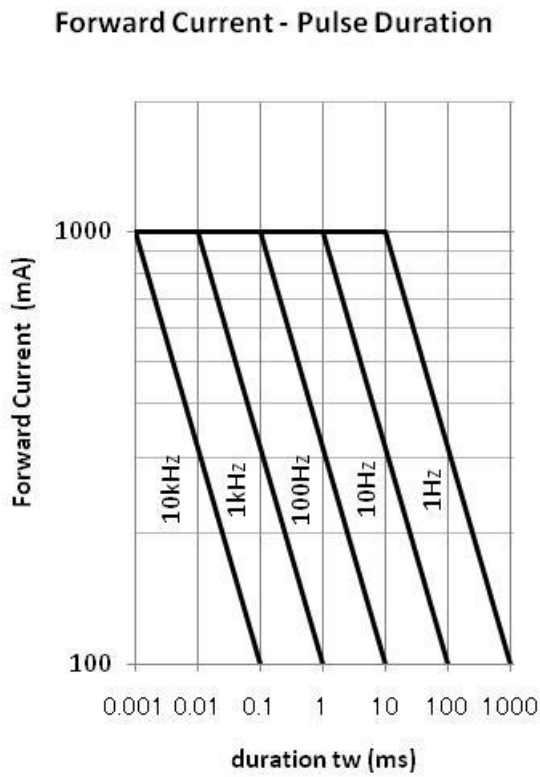
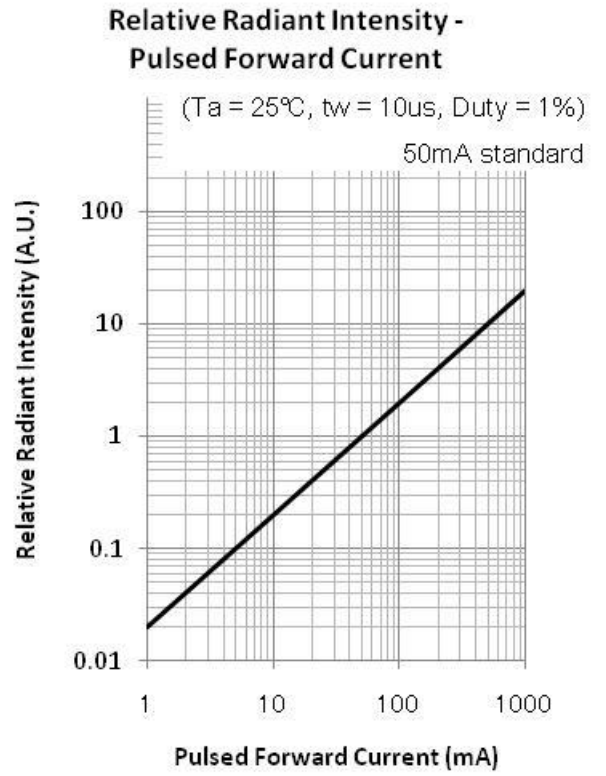
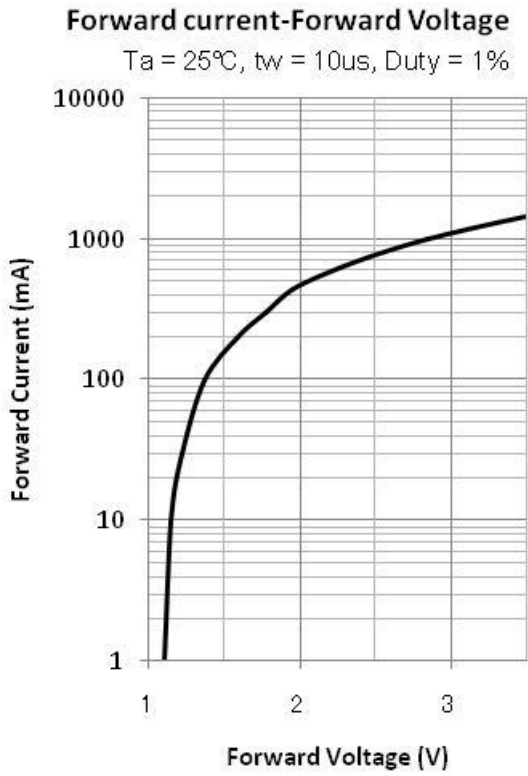

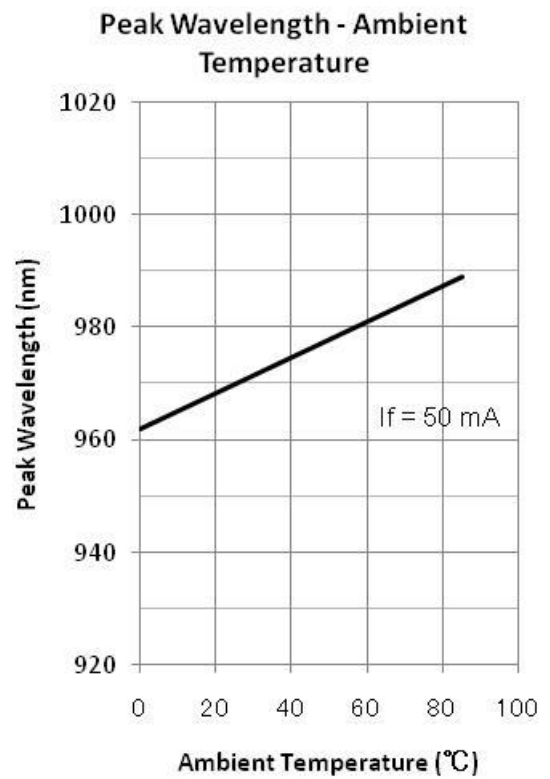
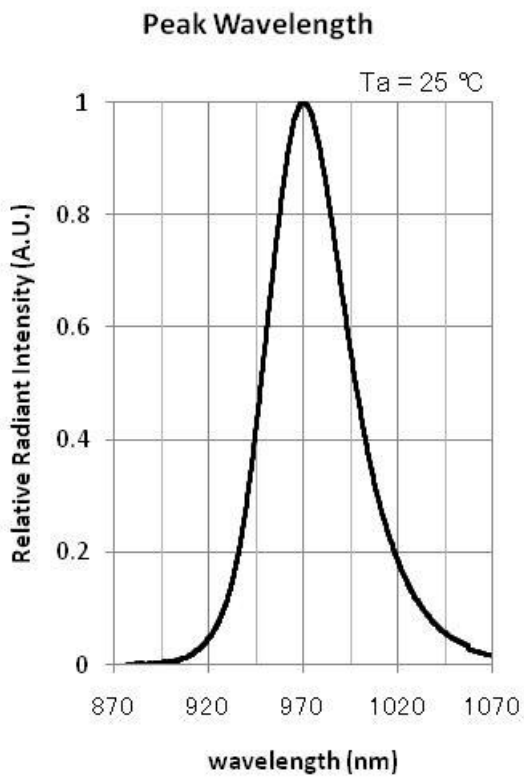
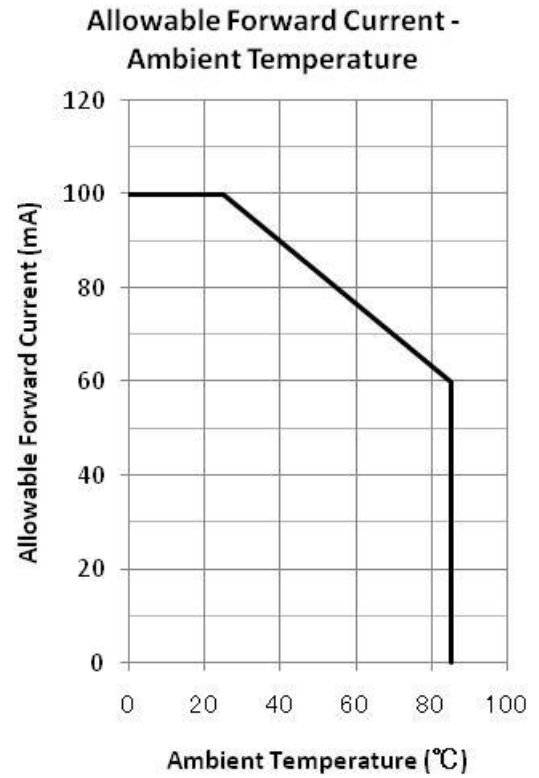
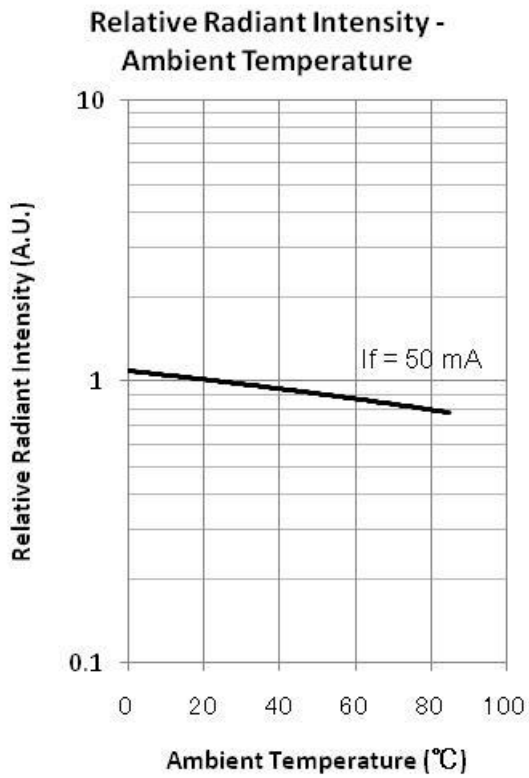

Recommended Land Layout (unit: mm)

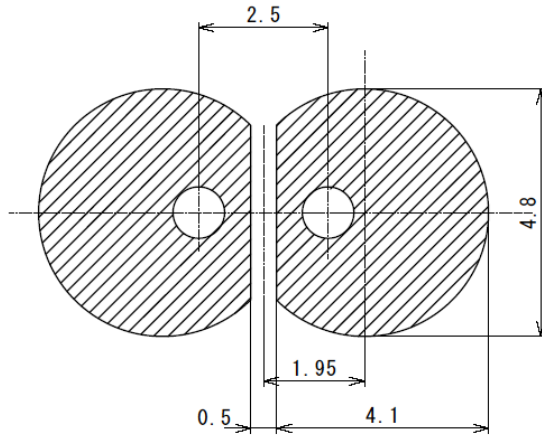

Soldering Conditions

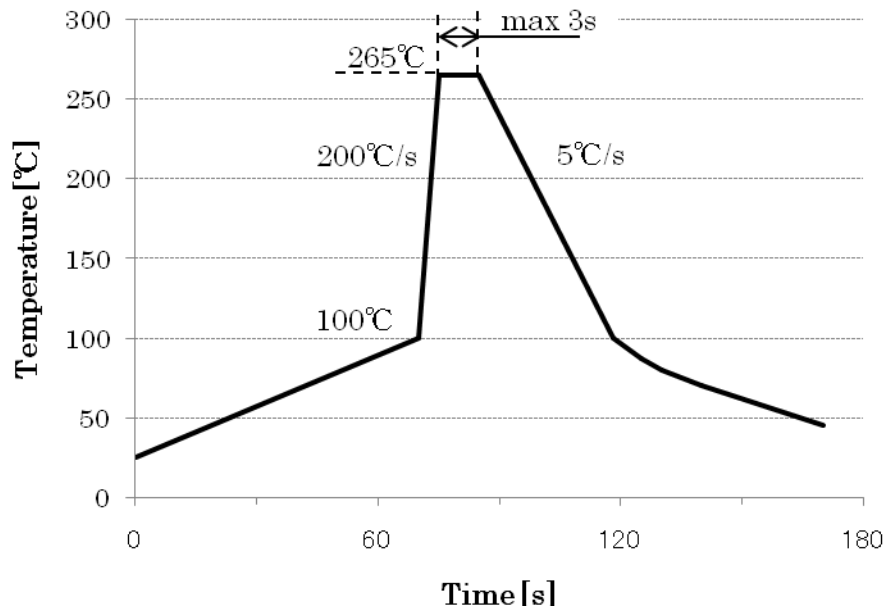

Marubeni America Corporation