

L505-__ __

Bluish Green LED Lamp

This series of L505-__ __ is an InGaN LED mounted on a lead frame with a clear epoxy lens. On forward bias, it emits a band of visible light peaks 505nm.

Specifications

- | | |
|--------------------|-------------------|
| 1. Chip material | InGaN |
| 2. Peak wavelength | 505nm typ. |
| 3. Resin Material | Clear epoxy Resin |
| 4. Solder | Lead free |



Absolute Maximum Ratings

Item	Symbol	Maximum Rated Value	Unit	Ambient Temperature
Power Dissipation	P_D	200	mW	$T_a=25^{\circ}\text{C}$
Forward Current	I_F	50	mA	$T_a=25^{\circ}\text{C}$
Reverse Voltage	V_R	5	V	$T_a=25^{\circ}\text{C}$
Operating Temperature	T_{OPR}	-30 ~ +85	$^{\circ}\text{C}$	$T_a=25^{\circ}\text{C}$
Storage Temperature	T_{STG}	-40 ~ +100	$^{\circ}\text{C}$	
Soldering Temperature	T_{SOL}	265	$^{\circ}\text{C}$	

Electro-Optical Characteristics ($T_a=25^{\circ}\text{C}$)

Item	Symbol	Condition	Minimum	Typical	Maximum	Unit
Forward Voltage	V_F	$I_F=20\text{mA}$		3.5	4.0	V
Reverse Current	I_R	$V_R=5\text{V}$			10	μA
Radiated Power	P_O	$I_F=20\text{mA}$		8.0		mW
Peak Wavelength	λ_P	$I_F=20\text{mA}$	495	505	515	nm
Half Width	$\Delta\lambda$	$I_F=20\text{mA}$		35		nm

Characteristics of Radiant Intensity (Ta=25°C)

Type	Viewing Half Angle	Brightness I _F =20mA Unit : mcd			Outer Dimension	Dimension Figure
		Minimum	Typical	Maximum		
L505-01	±8°		17000		Φ 5	1
L505-02	±5°		20000		Φ 5	2
L505-03	±10°		17000		Φ 5	3
L505-04	±20°		5000		Φ 5	4
L505-05	±50°		850		Φ 5	5
L505-06	±4°		24000		Φ 5	6
L505-09	±25°(Long) ±10°(Short)		10000		Φ 5 Oval	7
L505-46					Φ 5	8
L505-41	±14°				Φ 4	9
L505-42	±20°				Φ 4	10
L505-31					Φ 3	11
L505-33	±13°		9100		Φ 3	12
L505-34					Φ 3	13
L505-36	±25°		4300		Φ 3	14

Radiated Power is measured by S3584-08.
 Brightness is measured by Tektronix J-16

Outer Dimension of LED Lamp

<p>Figure-1 Φ 5Mold (Type01)</p> <p>cup position 4.7 1.5max</p> <p>$\phi 5.8 \pm 0.2$ $\phi 5 \pm 0.2$</p> <p>9± 0.2 21 min. Cathode 1 typ.</p> <p>1.0± 0.2 Anode 2-0.5sq± 0.1</p>	<p>Figure-2 Φ 5Mold (Type02)</p> <p>cup position 5.32 1.5max</p> <p>$\phi 5.8 \pm 0.2$ $\phi 5.2 \pm 0.2$</p> <p>8.5± 0.2 21 min. Cathode 1 typ.</p> <p>1.0± 0.2 Anode 2-0.5sq± 0.1</p>
<p>Figure-3 Φ 5Mold (Type03)</p> <p>cup position 4.55 1.5max</p> <p>$\phi 5.8 \pm 0.2$ $\phi 5 \pm 0.2$</p> <p>8.25± 0.2 21 min. Cathode 1 typ.</p> <p>1.0± 0.2 Anode 2-0.5sq± 0.1</p>	<p>Figure-4 Φ 5Mold (Type04)</p> <p>cup position 3.55 1.5max</p> <p>$\phi 5.8 \pm 0.2$ $\phi 5 \pm 0.2$</p> <p>7.7± 0.2 21 min. Cathode 1 typ.</p> <p>1.0± 0.2 Anode 2-0.5sq± 0.1</p>
<p>Figure-5 Φ 5Mold (Type05)</p> <p>cup position 0.55 1.5max</p> <p>$\phi 5.4 \pm 0.2$ $\phi 4.8 \pm 0.2$</p> <p>20.25 21 min. Cathode 1 typ.</p> <p>$\phi 4.45 \pm 0.2$ 1.0± 0.2 Anode 2-0.5sq± 0.1</p>	<p>Figure-6 Φ 5Mold (Type06)</p> <p>cup position 5.6 1.5max</p> <p>$\phi 5.5 \pm 0.2$</p> <p>8.7± 0.2 21 min. Cathode 1 typ.</p> <p>Anode 2-0.5sq± 0.1</p>
<p>Figure-7 Φ 5Mold (Type09)</p> <p>cup position 4.1 1.5max</p> <p>4.7± 0.2 7.7± 0.2 21 min. Cathode 1 typ.</p> <p>5.5± 0.2 Anode 2-0.5sq± 0.1</p>	<p>Figure-8 Φ 5Mold (Type46)</p> <p>1.5max</p> <p>$\phi 5.8 \pm 0.2$ $\phi 4.8 \pm 0.2$</p> <p>4.4± 0.2 21 min. Cathode 1 typ.</p> <p>0.6 Anode 2-0.5sq± 0.1</p>
<p>Figure-9 Φ 4Mold (Type41)</p> <p>cup position 3.05 1max</p> <p>$\phi 4.7 \pm 0.2$ $\phi 3.9 \pm 0.2$</p> <p>6.45± 0.2 21 min. Cathode 1 typ.</p> <p>1.5± 0.2 Anode 2-0.5sq± 0.1</p>	<p>Figure-10 Φ 4Mold (Type42)</p> <p>cup position 3.05 1max</p> <p>$\phi 4.7 \pm 0.2$ $\phi 3.9 \pm 0.2$</p> <p>6.45± 0.2 21 min. Cathode 1 typ.</p> <p>1.5± 0.2 Anode 2-0.5sq± 0.1</p>

Outer Dimension of LED Lamp

<p>Figure-11 Φ 3Mold (Type31) cup position</p> <p>0.37 1max 3.5±0.2 21 min. Cathode 1 typ. Anode 2-0.5sq±0.1 1.5 typ. ϕ 3.6±0.2 ϕ 3±0.2</p>	<p>Figure-12 Φ 3Mold (Type33) cup position</p> <p>2.65 1max 5.3 21 min. Cathode 1 typ. Anode 2-0.5sq±0.1 0.8 typ. ϕ 3.8±0.2 ϕ 3±0.2</p>
<p>Figure-13 Φ 3Mold (Type34) cup position</p> <p>3.25 1max 5.3±0.2 21 min. Cathode 1 typ. Anode 2-0.5sq±0.1 1.5 typ. ϕ 3.8±0.2 ϕ 3±0.2</p>	<p>Figure-14 Φ 3Mold (Type36) cup position</p> <p>2.1 1max 5.3±0.2 21 min. Cathode 1 typ. Anode 2-0.5sq±0.1 2±0.4 ϕ 4±0.2 ϕ 3±0.2</p>
<p>Figure-15</p>	<p>Figure-16</p>
<p>Figure-17</p>	<p>Figure-18</p>
<p>Figure-19</p>	<p>Figure-20</p>

The Viewing half angle

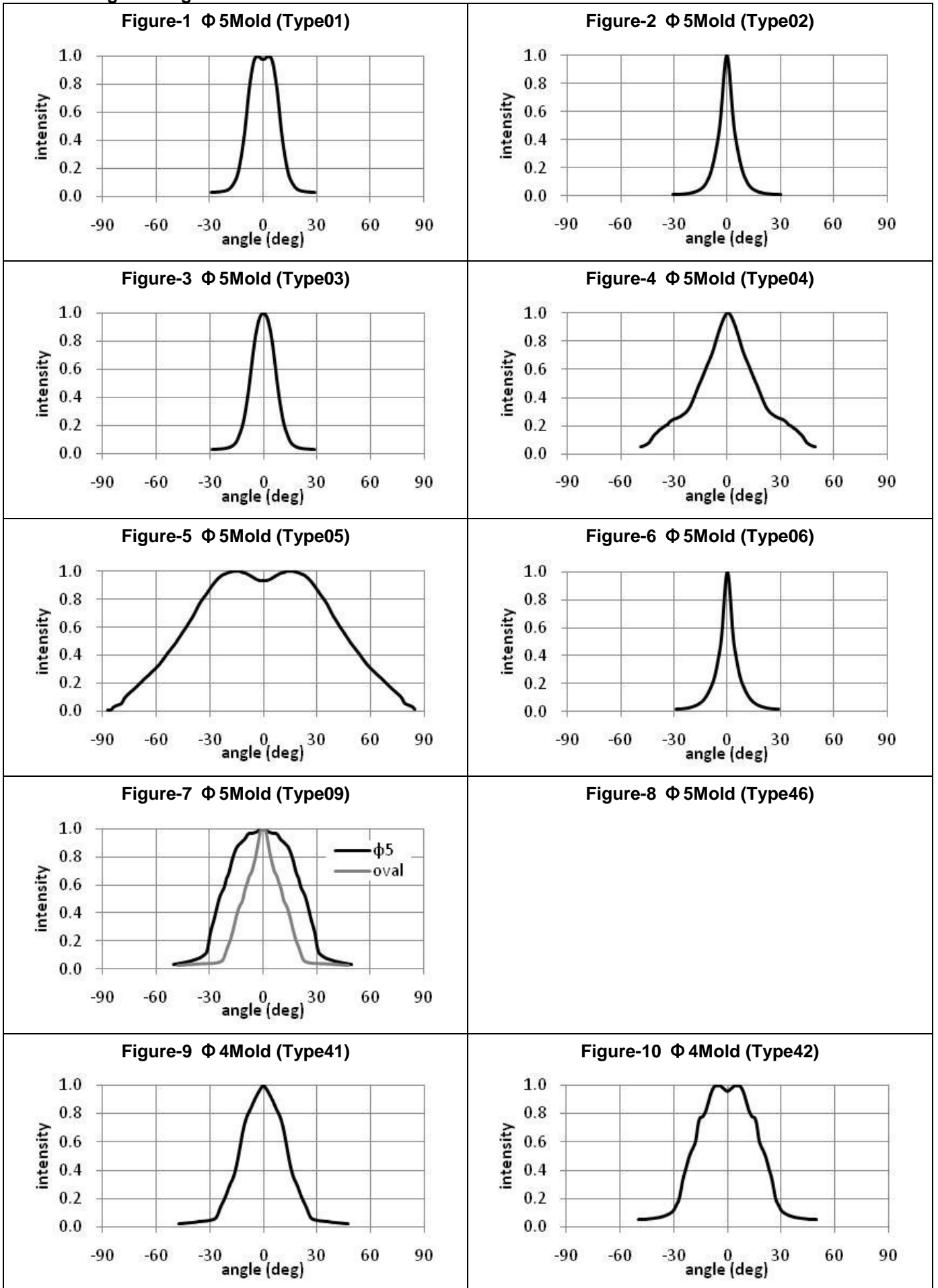

The Viewing half angle

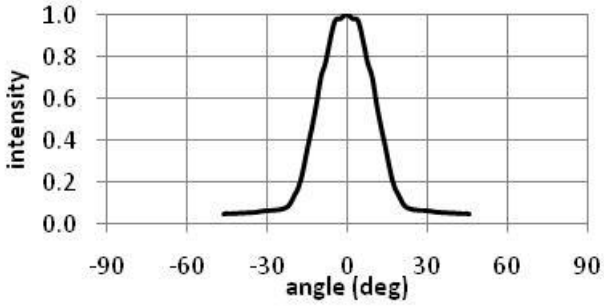
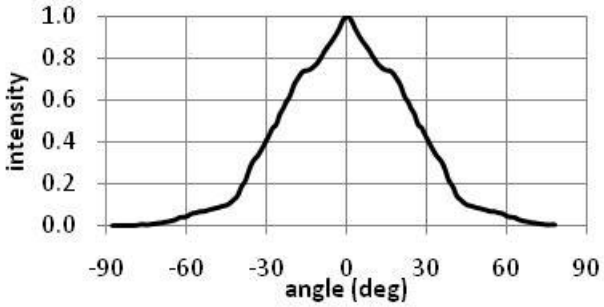
<p>Figure-11 Φ 3Mold (Type31)</p>	<p>Figure-12 Φ 3Mold (Type33)</p> 
<p>Figure-13 Φ 3Mold (Type34)</p>	<p>Figure-14 Φ 3Mold (Type36)</p> 
<p>Figure-15</p>	<p>Figure-16</p>
<p>Figure-17</p>	<p>Figure-18</p>
<p>Figure-19</p>	<p>Figure-20</p>

Forward current-Forward Voltage

$T_a = 25^\circ\text{C}$, $t_w = 10\mu\text{s}$, Duty = 1%

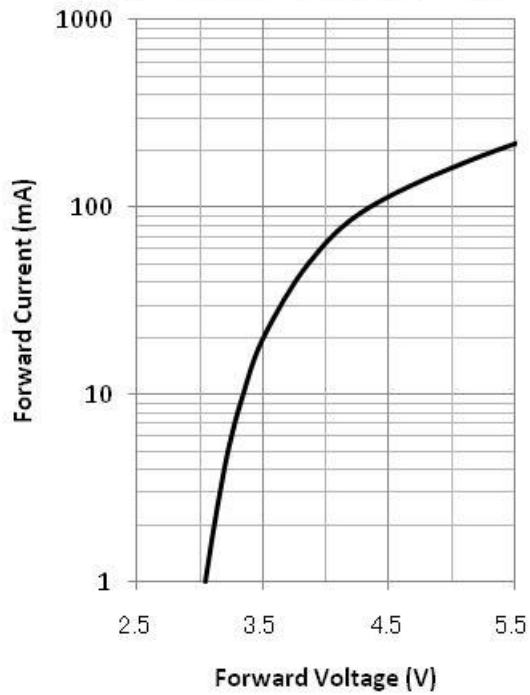

Relative Radiant Intensity - Pulsed Forward Current

$(T_a = 25^\circ\text{C}, t_w = 10\mu\text{s}, \text{Duty} = 1\%)$

20mA standard

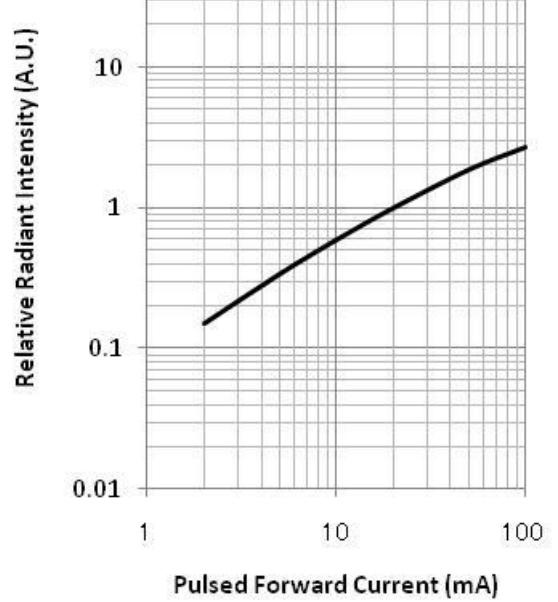

Forward Voltage - Ambient Temperature

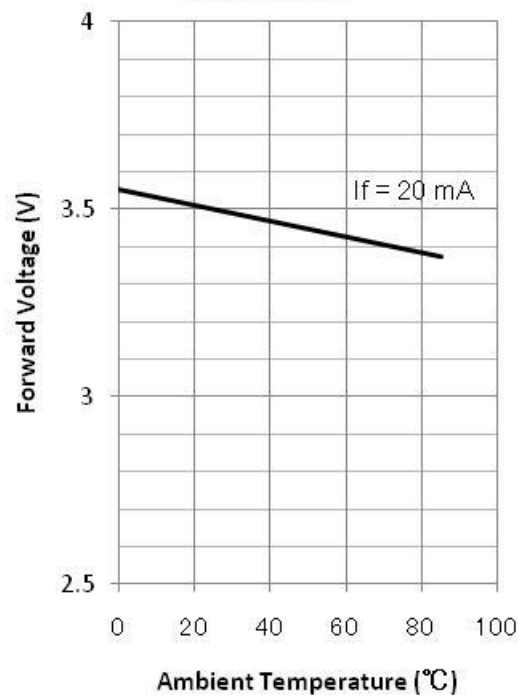

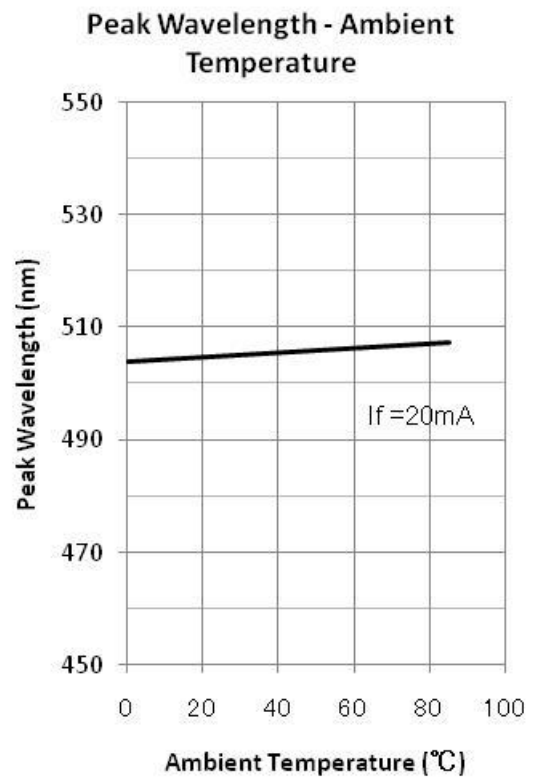
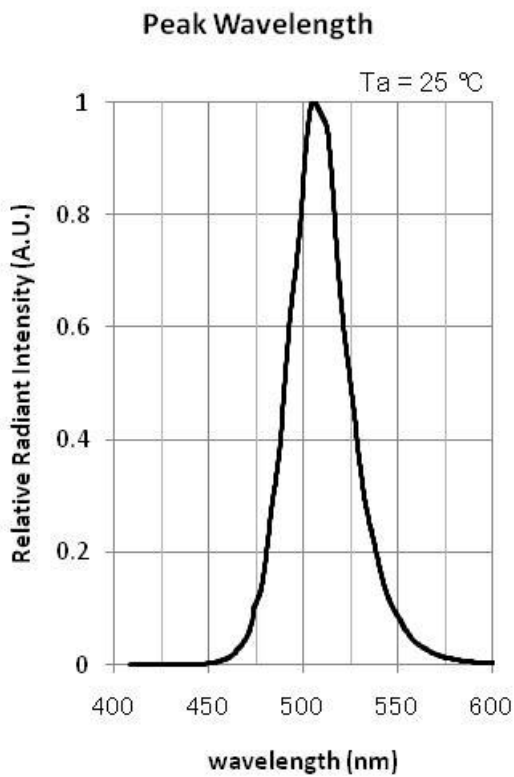
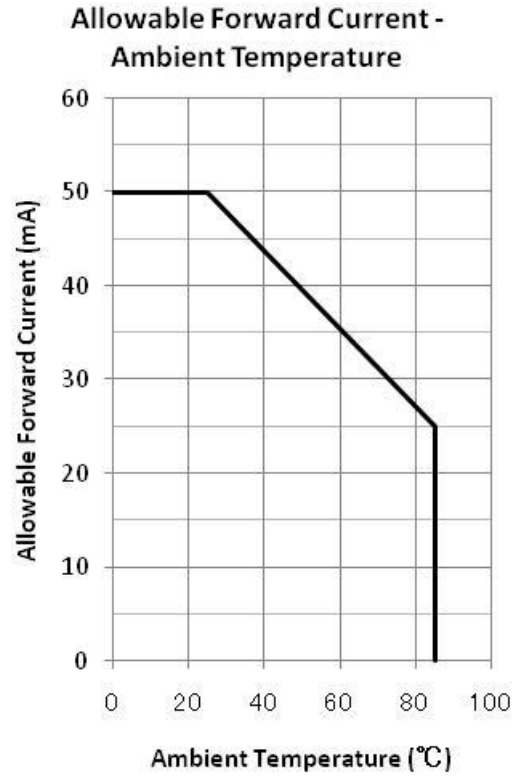
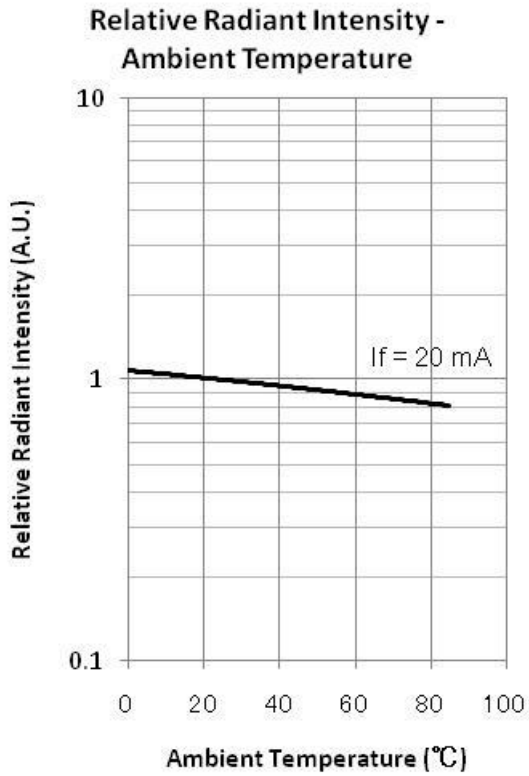

Recommended Land Layout (unit: mm)

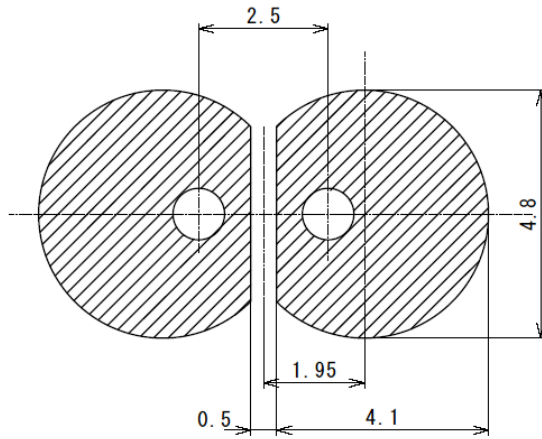

Soldering Conditions

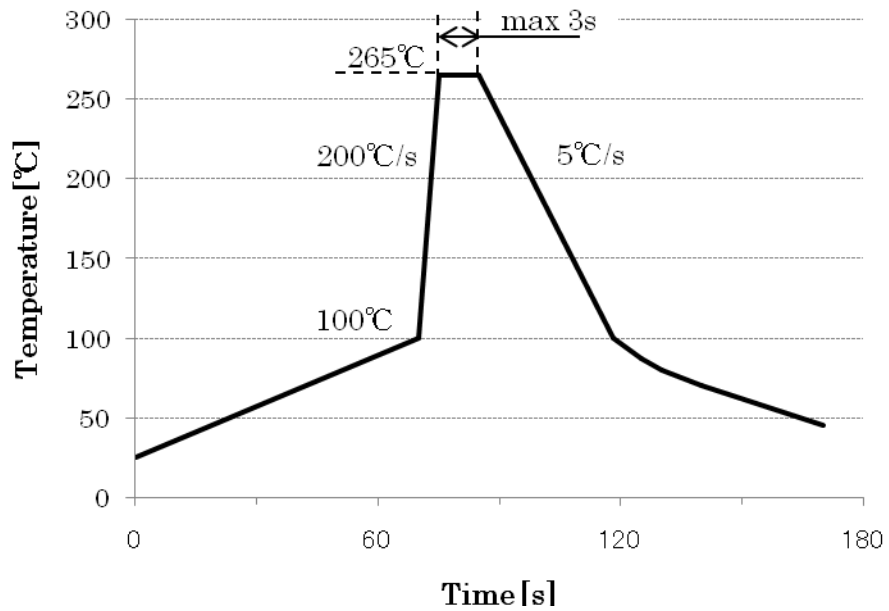

Marubeni America Corporation

3945 Freedom Circle, Suite 1000, Santa Clara, CA 95054 408-330-0650 (Ext. 330), 408-330-0655 (Fax), sales@tech-led.com